

Hallenpläne
mit Aussteller-Übersicht
Hall floor plans
with overview of exhibitors

5



Stil & Design
Style & Design



Haus & Garten
Home & Garden



Geschenke & Papeterie
Gifts & Stationery



Souvenirs



Küche & Genuss
Kitchen & Gourmet

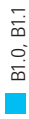

Schmuck & Mode
Jewellery & Fashion



Entspannung & Pflege
Relaxation & Well-Being



Stand: Dezember 2017. Änderungen vorbehalten.
As of December 2017. Subject to change.

Hallenpläne

Hall floor plans

Halle Hall	Seite Page
A1	238
A2	242
A3	246
A4	252
B1.0	260
B1.1	264
B2	266
B3	270
B4	272
B5	274
B7	278

Halle A1 Hall A1

Haus & Garten
Home & Garden

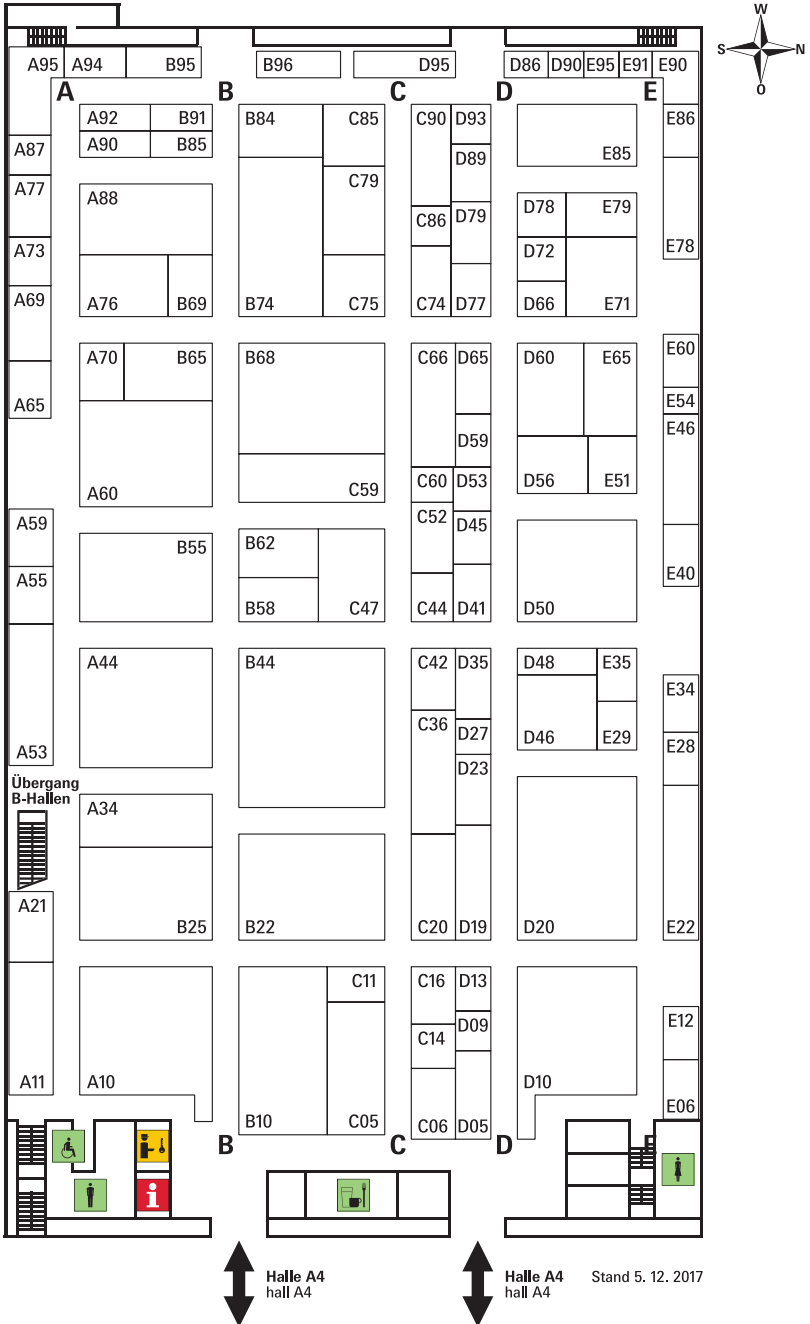

Stand 5. 12. 2017

alphabetisch

acentro	A1.0 E60	Evelyn Kahle GmbH	A1.0 C44
Affari AB	A1.0 B22	Kardelen AB	A1.0 C75
albert L. (punkt) Sandra Schröder	A1.0 D50	Koustrup & Co. ApS	A1.0 D78
AM-Design Floristik GmbH	A1.0 D10	Krasilnikoff A/S	A1.0 D19
Ambiente Europe B.V.	A1.0 D60	KunstIndustrien v/Mette Røjgaard	A1.0 B85
Ambiente Haus GmbH	A1.0 A11	L'ESPRIT DU SUD	A1.0 D86
Andersson Supply v/ Birgitte Andersson	A1.0 E79	La Casa di Caesar GmbH	A1.0 B68
Andrew's Living Rooms		La Finesse Lager ApS	A1.0 B65
Inh. Andrew Finch	A1.0 D45	La Maison Diedr. Lindemann KG	A1.0 A76
Atelier Heidi - Heidi Metzner e.K.	A1.0 D13	Lexington CE GmbH	A1.0 C90
Augenstolz - Michael Boock	A1.0 E12	Lübeck Living ApS	A1.0 D66
Baden GmbH	A1.0 B55	Me & Marie	A1.0 D95
Bastion Collections	A1.0 E46	Mea-Living GmbH	A1.0 B91
BlogUps - Michaela Hoehchst-Lühr	A1.0 C60	Meander	A1.0 C66
Bottlelight Company - Dr. Kitzenmaier, Leuchten	A1.0 D90	MEYER-MAYOR AG	A1.0 D27
Busatti s.r.l.	A1.0 E51	Morocco Interiors	A1.0 A77
by Room v/Annette Torbensen	A1.0 E71	Münder-Email GmbH	A1.0 B95
Candle Factory, Dennis Gödeke e.K.	A1.0 D89	Müsing Handelsvertretung	A1.0 B96
Carina Hägg Design	A1.0 E95	Exotica Cor Mulder GmbH	A1.0 A10
Cees&Co	A1.0 C85	Nääsgränsgården AB	A1.0 D09
Clayre & Eef B.V.	A1.0 E85	Nature and Style	
Cotex Textilvertrieb GmbH	A1.0 D50	Wohnkultur Import GmbH	A1.0 D50
Cotton Ball Lights		Natures Collection A/S	A1.0 C06
InhaberIn: Marlot Meinema	A1.0 A59	NORDIKA design e.K.	A1.0 A70
D & T Design Hamburg GmbH	A1.0 D05	Norrlandsmöbler - Ismael Volk	A1.0 E91
Danishville, M.K. Jacobsen	A1.0 D65	Marion Paredes GmbH	A1.0 C11
DP Danmark A/S	A1.0 E78	PAW Sp. z o.o.	A1.0 A87
Silke Daut	A1.0 B62	PLINT A/S	A1.0 A65
DE MiM Illustration & Design		Pure Culture A/S	A1.0 D56
Miriam Kramer	A1.0 E28	Sander GmbH & Co. KG	
Gabriele Gräfin Deym – british-living Brookspace Lascelles	A1.0 D77	TABLE + HOME	A1.0 E35
Ekelund, Linneväveriet i Horred AB	A1.0 C16	Sanita Footwear A/S	A1.0 D53
Five Minutes B.V.	A1.0 C86	Jürgen Schleiß Konfektion	A1.0 D35
Flair Vitrine Glas		Schneider & Friends	
Porzellan Handels GmbH	A1.0 A76	Inh. Franz J. Schneider	A1.0 C42
GAMA Import-Export		Schweden Produkte	A1.0 C14
Inh. Margareta Garba	A1.0 A94	Schwedenstil OHG	A1.0 A55
Kunstgewerbe Gehlmann e.K.	A1.0 B25	AVENUE38 - Guido EW Schwettmann	A1.0 D59
La Casa Gerber	A1.0 E29	Sieger Design Lifestyle GmbH	A1.0 C47
GILDE HANDWERK	A1.0 A44	SIGNATURE HOME	
Macrander GmbH & Co. KG	A1.0 A53	COLLECTION GmbH	A1.0 A21
Giszas GmbH	A1.0 A73	Solwang Design ApS	
GreenGate Europe A/S	A1.0 C05	vertreten durch Danishville	A1.0 D65
Gronlykke.com ApS	A1.0 D72	SOULforSEAL by United Comfort ApS	A1.0 D48
Hazenkamp Furnitures BV.	A1.0 A88	Steen Design Willo Steen	A1.0 C20
Heitmann Felle GmbH	A1.0 B69	Dr. J. Volkmar Stöber	A1.0 E22
hell & gut M. O. Leuchten GmbH	A1.0 E06	SweetDesign by Nala Christian Euwens	A1.0 E40
Hoff-Interieur GmbH & Co. KG	A1.0 B10	TAFELGUT GbR	A1.0 E65
Joachim Holländer	A1.0 B84	TheMoshi AB	A1.0 C59
HOLZWURM	A1.0 C36	Erika Vaitkute - Leinen aus Litauen	A1.0 D41
Hoogendam International V.O.F.	A1.0 C79	van Deurs Danmark	A1.0 D46
Hossner Heimtex GmbH	A1.0 C52	Van Verre	A1.0 C74
IHR Ideal Home Range GmbH	A1.0 A34	Vintage & Rags Yeterian oHG	A1.0 E86
Imbarro	A1.0 D79	VL Home Collection GbR	A1.0 A90
invero GmbH	A1.0 B58	Werner Voß GmbH Handel & Marketing	A1.0 D20
italB. Birgit Jörgens (Einzelirma)	A1.0 E34	Walter & Prediger GmbH & Co. KG	A1.0 A95
JET Papier GmbH	A1.0 E90	Westfalenstoffe AG	A1.0 D23
Ju-Lein GmbH	A1.0 D93	wirework – contemporary south african handcraft	
Kaheku Schönes Wohnen GmbH	A1.0 B74	Inh. Michelle Schingerlin	A1.0 E54
		Wohnmanufaktur Grünberger S.r.o.	A1.0 A60
		Handelsvertretungen Kerstin Wollner	A1.0 A69
		Wollzeit GmbH	A1.0 A92
		G. Wurm GmbH + Co. KG	A1.0 B44

Halle A1 Hall A1

Haus & Garten
Home & Garden

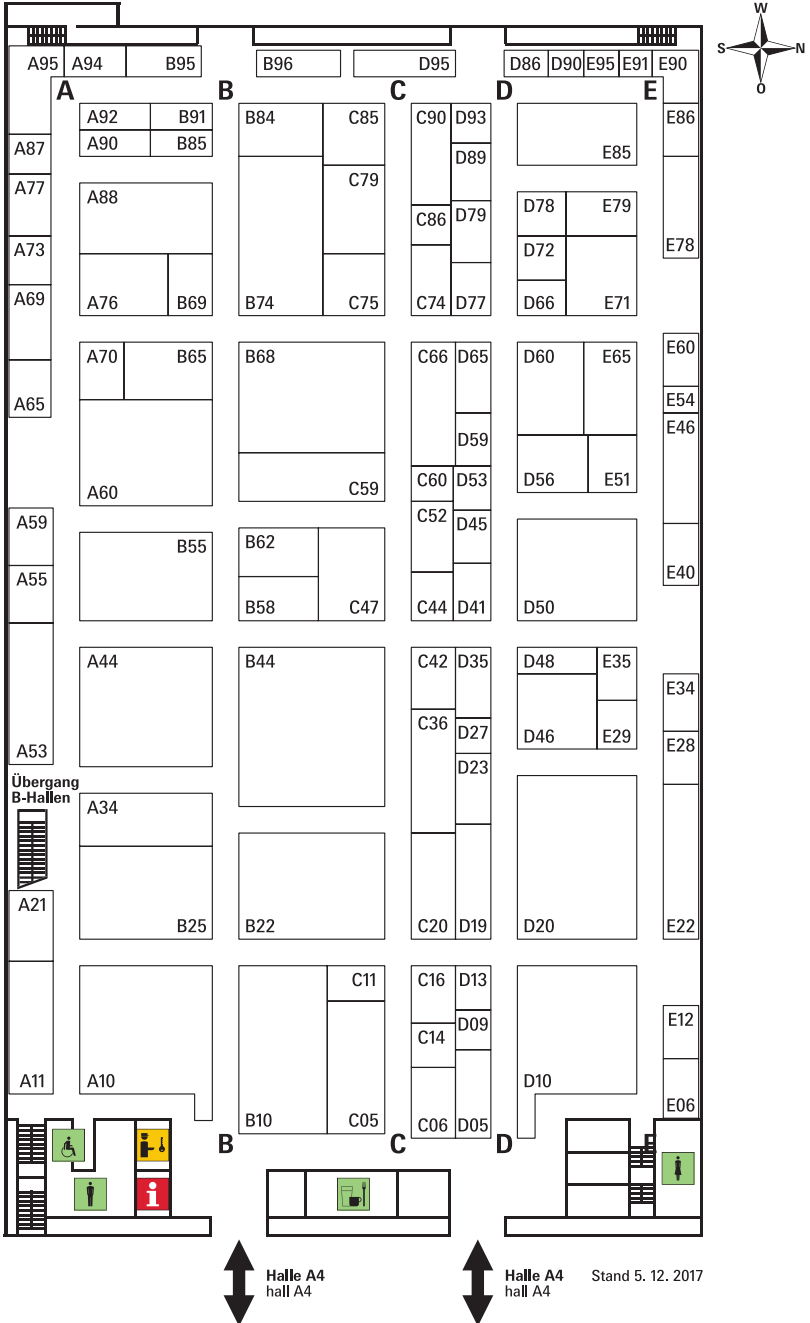

nach Standnummer

Exotica Cor Mulder GmbH	A1.0 A10	Lexington CE GmbH	A1.0 C90
Ambiente Haus GmbH	A1.0 A11	D & T Design Hamburg GmbH	A1.0 D05
SIGNATURE HOME		Näasgränsgarden AB	A1.0 D09
COLLECTION GmbH	A1.0 A21	AM-Design Floristik GmbH	A1.0 D10
IHR Ideal Home Range GmbH	A1.0 A34	Atelier Heidi - Heidi Metzner e.K.	A1.0 D13
GILDE HANDWERK	A1.0 A44	Krasilnikoff A/S	A1.0 D19
Macrander GmbH & Co. KG	A1.0 A53	Werner Voß GmbH	
Schwedenstil OHG	A1.0 A55	Handel & Marketing	A1.0 D20
Cotton Ball Lights		Westfalenstoffe AG	A1.0 D23
InhaberIn: Marlot Meinema	A1.0 A59	MEYER-MAYOR AG	A1.0 D27
Wohnmanufactur Grünberger S.r.o.	A1.0 A60	Jürgen Schleiß Konfektion	A1.0 D35
PLINT A/S	A1.0 A65	Erika Vaitkute - Leinen aus Litauen	A1.0 D41
Handelsvertretungen Kerstin Wollner	A1.0 A69	Andrew's Living Rooms	
NORDIKA design e.K.	A1.0 A70	Inh. Andrew Finch	A1.0 D45
Giszas GmbH	A1.0 A73	van Deurs Danmark	A1.0 D46
Flair Vitrine Glas		SOULforSEAL by United Comfort ApS	A1.0 D48
Porzellan Handels GmbH	A1.0 A76	albert L. (punkt) Sandra Schröder	A1.0 D50
La Maison Diedr. Lindemann KG	A1.0 A76	Cotex Textilvertrieb GmbH	A1.0 D50
Morocco Interiors	A1.0 A77	Nature and Style	
PAW Sp. z o.o.	A1.0 A87	Wohnkultur Import GmbH	A1.0 D50
Hazenkamp Furnitures BV.	A1.0 A88	Sanita Footwear A/S	A1.0 D53
VL Home Collection GbR	A1.0 A90	Pure Culture A/S	A1.0 D56
Wollzeit GmbH	A1.0 A92	AVENUE38 - Guido EW Schwettmann	A1.0 D59
GAMA Import-Export		Ambiente Europe B.V.	A1.0 D60
Inh. Margareta Garba	A1.0 A94	Danishville, M.K. Jacobsen	A1.0 D65
Walter & Prediger GmbH & Co. KG	A1.0 A95	Solwang Design ApS	
Hoff-Interieur GmbH & Co. KG	A1.0 B10	vertreten durch Danishville	A1.0 D65
Affari AB	A1.0 B22	Lübeck Living ApS	A1.0 D66
Kunstgewerbe Gehlmann e.K.	A1.0 B25	Gronlykke.com ApS	A1.0 D72
G. Wurm GmbH + Co. KG	A1.0 B44	Gabriele Gräfin Deym - british-living	
Baden GmbH	A1.0 B55	Brookpace Lascelles	A1.0 D77
invero GmbH	A1.0 B58	Koustrup & Co. ApS	A1.0 D78
Silke Daut	A1.0 B62	Imbarro	A1.0 D79
La Finesse Lager ApS	A1.0 B65	L'ESPRIT DU SUD	A1.0 D86
La Casa di Caesar GmbH	A1.0 B68	Candle Factory, Dennis Gödeke e.K.	A1.0 D89
Heitmann Felle GmbH	A1.0 B69	Bottlelight Company -	
Kaheku Schönes Wohnen GmbH	A1.0 B74	Dr. Kitzenmaier, Leuchten	A1.0 D90
Joachim Holländer	A1.0 B84	Ju-Lein GmbH	A1.0 D93
KunstIndustrien v/Mette Røjgaard	A1.0 B85	Me & Marie	A1.0 D95
Mea-Living GmbH	A1.0 B91	hell & gut M. O. Leuchten GmbH	A1.0 E06
Münder-Email GmbH	A1.0 B95	Augenstolz - Michael Boock	A1.0 E12
Müsing Handelsvertretung	A1.0 B96	Dr. J. Volkmar Stöber	A1.0 E22
GreenGate Europe A/S	A1.0 C05	DE MiM Illustration & Design	
Natures Collection A/S	A1.0 C06	Miriam Kramer	A1.0 E28
Marion Paredes GmbH	A1.0 C11	La Casa Gerber	A1.0 E29
Schweden Produkte	A1.0 C14	italB. Birgit Jörgens (Einzelfirma)	A1.0 E34
Ekelund, Linneväveriet i Horred AB	A1.0 C16	Sander GmbH & Co. KG	
Steen Design Willo Steen	A1.0 C20	TABLE + HOME	A1.0 E35
HOLZWURM	A1.0 C36	SweetDesign by Nala Christian Euwens	A1.0 E40
Schneider & Friends		Bastion Collections	A1.0 E46
Inh. Franz J. Schneider	A1.0 C42	Busatti s.r.l.	A1.0 E51
Evelyn Kahle GmbH	A1.0 C44	wirework - contemporary	
Sieger Design Lifestyle GmbH	A1.0 C47	south african handcraft	
Hossner Heimtex GmbH	A1.0 C52	Inh. Michèle Schingerlin	A1.0 E54
TheMoshi AB	A1.0 C59	acentro	A1.0 E60
BlogUps - Michaela Hoehchst-Lühr	A1.0 C60	TAFELGUT GbR	A1.0 E65
Meander	A1.0 C66	by Room v/Annette Torbensen	A1.0 E71
Van Verre	A1.0 C74	DP Danmark A/S	A1.0 E78
Kardelen AB	A1.0 C75	Andersson Supply v/	
Hoogendam International V.O.F.	A1.0 C79	Birgitte Andersson	A1.0 E79
Cees&Co	A1.0 C85	Clay & Eef B.V.	A1.0 E85
Five Minutes B.V.	A1.0 C86	Vintage & Rags Yeterian oHG	A1.0 E86
		JET Papier GmbH	A1.0 E90
		Norrlandsmöbler - Ismael Volk	A1.0 E91
		Carina Hägg Design	A1.0 E95

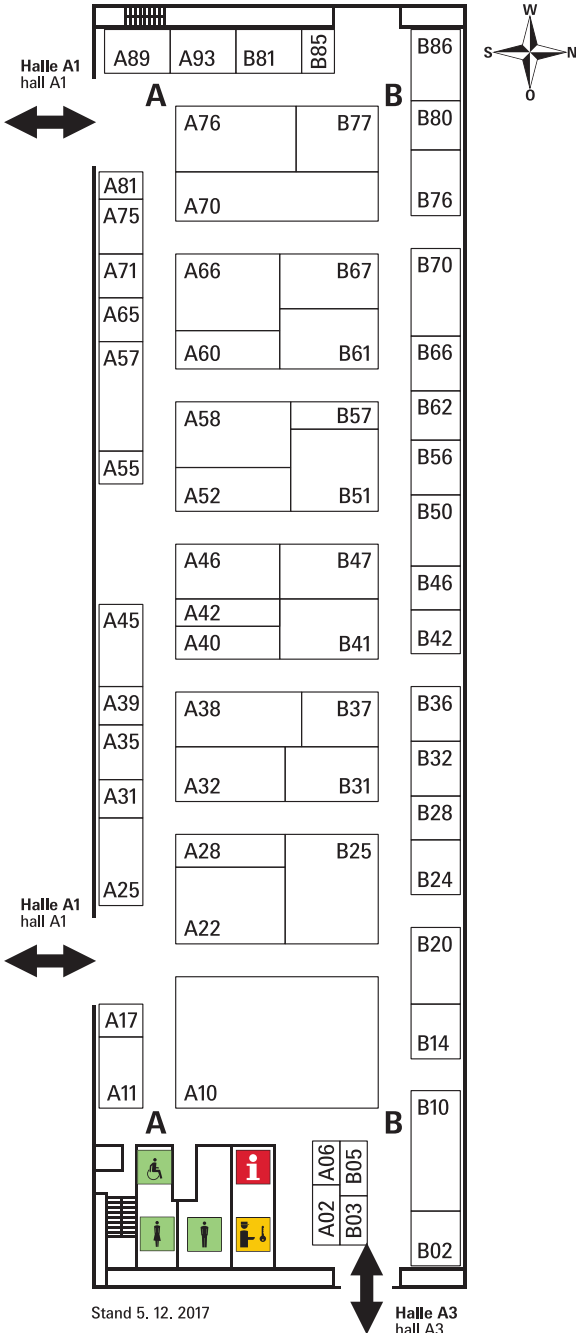

alphabetisch

ABC - Glückwunschkarten		Trendhaus Handelsgesellschaft mbH	A2.0 B61
A. Boss + Co. AG	A2.0 A38	Trullala Spielwaren GmbH	A2.0 A89
Allegro Raimund Epping	A2.0 B28	TST T-Shirt-Total GmbH	A2.0 B51
Artoz Papier AG	A2.0 A22	VELOFLEX	
Baier & Schneider GmbH & Co. KG	A2.0 A10	Carsten Thormählen GmbH & Co. KG	A2.0 B20
Ballaballa GmbH	A2.0 B80	Verenigde Speelgoedindustriën	
Beacher Handelsagentur Kramer	A2.0 A81	Elcee-Haly B.V.	A2.0 A39
CoastCards Comic-Postkarten	A2.0 A65	Edition Wannenbuch – Verlag Jens Korch	A2.0 A71
Werner Dorsch GmbH	A2.0 B02	Werkstätten Karthaus	A2.0 B86
DURABLE		Wunderle, Heike Bringemeier e.K.	A2.0 B57
Hunke & Jochheim GmbH & Co. KG	A2.0 B14	WUP oHG	A2.0 A46
edding Vertrieb GmbH	A2.0 B10		
Eko Saja d.o.o.	A2.0 A06		
Elecosy BVBA	A2.0 B05		
elements for kids GmbH	A2.0 B46		
Elliot GmbH	A2.0 B50		
ExaClair GmbH	A2.0 A58		
Flower-Function René Sausmikat	A2.0 A02		
FOND OF XYZ c/o MARK3 GmbH	A2.0 A55		
Gerstenberg Verlag GmbH & Co. KG	A2.0 B62		
GOLDBEK Verlag GmbH	A2.0 B77		
Hama GmbH & Co KG	A2.0 B31		
Klaus Hanfstingl Verlag GmbH	A2.0 B37		
H.C.A. Collection Handels-GmbH	A2.0 B81		
Inware GmbH	A2.0 A28		
Karsten, Marcus	A2.0 B32		
Kochformel	A2.0 A31		
Korsch Verlag GmbH & Co. KG	A2.0 A32		
La Rive Germany GmbH	A2.0 B03		
LILALU GmbH	A2.0 A52		
Lyra-Bleistift-Fabrik GmbH & Co. KG	A2.0 A11		
Mark Bric Display AB	A2.0 A40		
michel toys Handels-GmbH	A2.0 A70		
NICI GmbH	A2.0 A66		
nobis design Monica Nobis e.K.	A2.0 B85		
Nonbook & Co. Inh. Reinhard Stein	A2.0 A45		
Nostalgic-Art Merchandising GmbH	A2.0 B76		
Verlag Friedrich Oetinger GmbH	A2.0 B70		
Online Schreibgeräte GmbH	A2.0 B36		
PAGNA GmbH & Co. KG	A2.0 B14		
Pappnase & Co. GmbH	A2.0 A46		
Uwe Pein seit 1981 - Handelsvertretung CDH	A2.0 A57		
Pelikan			
Vertriebsgesellschaft mbH & Co. KG	A2.0 B25		
Perstorp Design AB	A2.0 A75		
Petit Jour Paris	A2.0 A42		
Pilot Pen (Deutschland) GmbH	A2.0 B24		
Roadtyping - Cards for Globetrotters	A2.0 A17		
Rössler Papier GmbH & Co. KG	A2.0 B47		
Sagro Verlag, Günter Grothkopp	A2.0 A35		
Udo Schmidt GmbH & Co. KG	A2.0 A76		
Schneider Novus Vertriebs GmbH	A2.0 A25		
Schöning GmbH & Co. KG	A2.0 A93		
Klaus Schürmann			
Handelsvertretungen CDH	A2.0 A60		
SHEEPWORLD AG	A2.0 B41		
Smart Toys and Games GmbH	A2.0 B56		
Souza! - Phanine B.V.	A2.0 B66		
Städtler MediaMarketing GmbH	A2.0 B42		
Taurus – Kunstkarten GmbH	A2.0 B67		

Halle A2 Hall A2

Geschenke & Papeterie
Gifts & Stationery

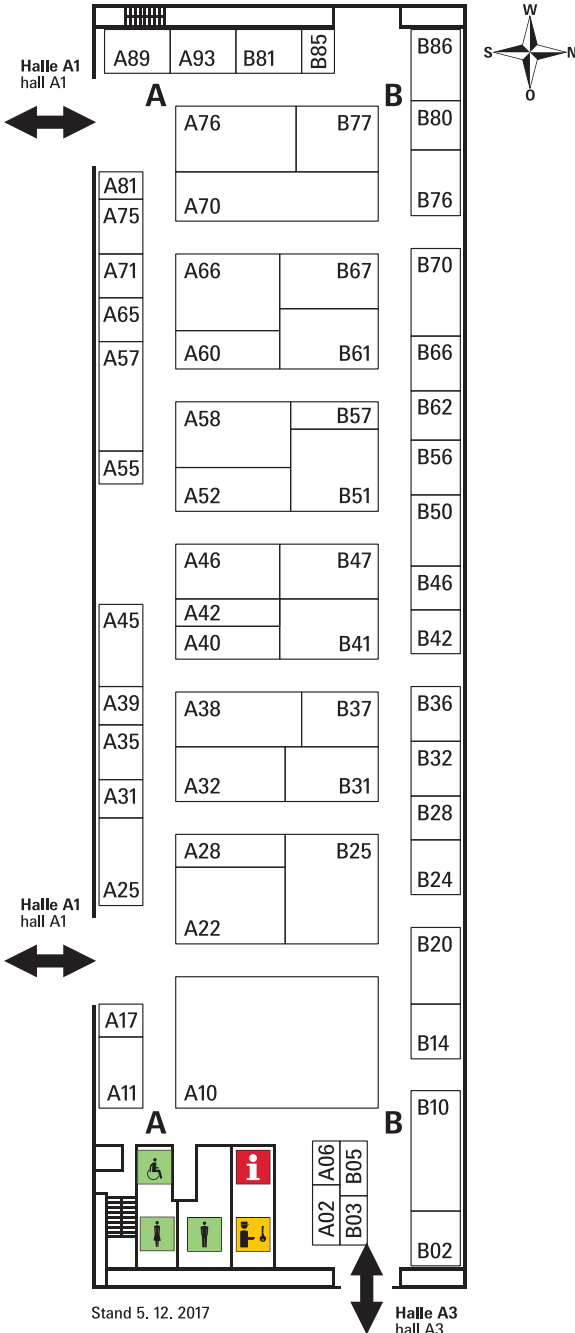

Stand 5. 12. 2017

Halle A3
hall A3

nach Standnummer

Flower-Function René Sausmikat	A2.0 A02	Trendhaus Handelsgesellschaft mbH	A2.0 B61
Eko Saja d.o.o.	A2.0 A06	Gerstenberg Verlag GmbH & Co. KG	A2.0 B62
Baier & Schneider GmbH & Co. KG	A2.0 A10	Souza! - Phanine B.V.	A2.0 B66
Lyra-Bleistift-Fabrik GmbH & Co. KG	A2.0 A11	Taurus – Kunstkarten GmbH	A2.0 B67
Roadtyping - Cards for Globetrotters	A2.0 A17	Verlag Friedrich Oetinger GmbH	A2.0 B70
Artoz Papier AG	A2.0 A22	Nostalgic-Art Merchandising GmbH	A2.0 B76
Schneider Novus Vertriebs GmbH	A2.0 A25	GOLDBEK Verlag GmbH	A2.0 B77
Inware GmbH	A2.0 A28	Ballaballa GmbH	A2.0 B80
Kochformel	A2.0 A31	H.C.A. Collection Handels-GmbH	A2.0 B81
Korsch Verlag GmbH & Co. KG	A2.0 A32	nobis design Monica Nobis e.K.	A2.0 B85
Sagro Verlag, Günter Grothkopp	A2.0 A35	Werkstätten Karthaus	A2.0 B86
ABC - Glückwunschkarten			
A. Boss + Co. AG	A2.0 A38		
Verenigde Speelgoedindustriën			
Elcee-Haly B.V.	A2.0 A39		
Mark Bric Display AB	A2.0 A40		
Petit Jour Paris	A2.0 A42		
Nonbook & Co. Inh. Reinhard Stein	A2.0 A45		
Pappnase & Co. GmbH	A2.0 A46		
WUP oHG	A2.0 A46		
LILALU GmbH	A2.0 A52		
FOND OF XYZ c/o MARK3 GmbH	A2.0 A55		
Uwe Pein seit 1981 - Handelsvertretung CDH	A2.0 A57		
ExaClair GmbH	A2.0 A58		
Klaus Schürmann Handelsvertretungen CDH	A2.0 A60		
CoastCards Comic-Postkarten	A2.0 A65		
NICI GmbH	A2.0 A66		
michel toys Handels-GmbH	A2.0 A70		
Edition Wannenbuch – Verlag Jens Korch	A2.0 A71		
Perstorp Design AB	A2.0 A75		
Udo Schmidt GmbH & Co. KG	A2.0 A76		
Beacher Handelsagentur Kramer	A2.0 A81		
Trullala Spielwaren GmbH	A2.0 A89		
Schöning GmbH & Co. KG	A2.0 A93		
Werner Dorsch GmbH	A2.0 B02		
La Rive Germany GmbH	A2.0 B03		
Elecosy BVBA	A2.0 B05		
edding Vertrieb GmbH	A2.0 B10		
DURABLE			
Hunke & Jochheim GmbH & Co. KG	A2.0 B14		
PAGNA GmbH & Co. KG	A2.0 B14		
VELOFLEX			
Carsten Thormählen GmbH & Co. KG	A2.0 B20		
Pilot Pen (Deutschland) GmbH	A2.0 B24		
Pelikan			
Vertriebsgesellschaft mbH & Co. KG	A2.0 B25		
Allegro Raimund Epping	A2.0 B28		
Hama GmbH & Co KG	A2.0 B31		
Karsten, Marcus	A2.0 B32		
Online Schreibgeräte GmbH	A2.0 B36		
Klaus Hanfstingl Verlag GmbH	A2.0 B37		
SHEEPWORLD AG	A2.0 B41		
Städtler MediaMarketing GmbH	A2.0 B42		
elements for kids GmbH	A2.0 B46		
Rössler Papier GmbH & Co. KG	A2.0 B47		
Elliot GmbH	A2.0 B50		
TST T-Shirt-Total GmbH	A2.0 B51		
Smart Toys and Games GmbH	A2.0 B56		
Wunderle, Heike Bringemeier e.K.	A2.0 B57		

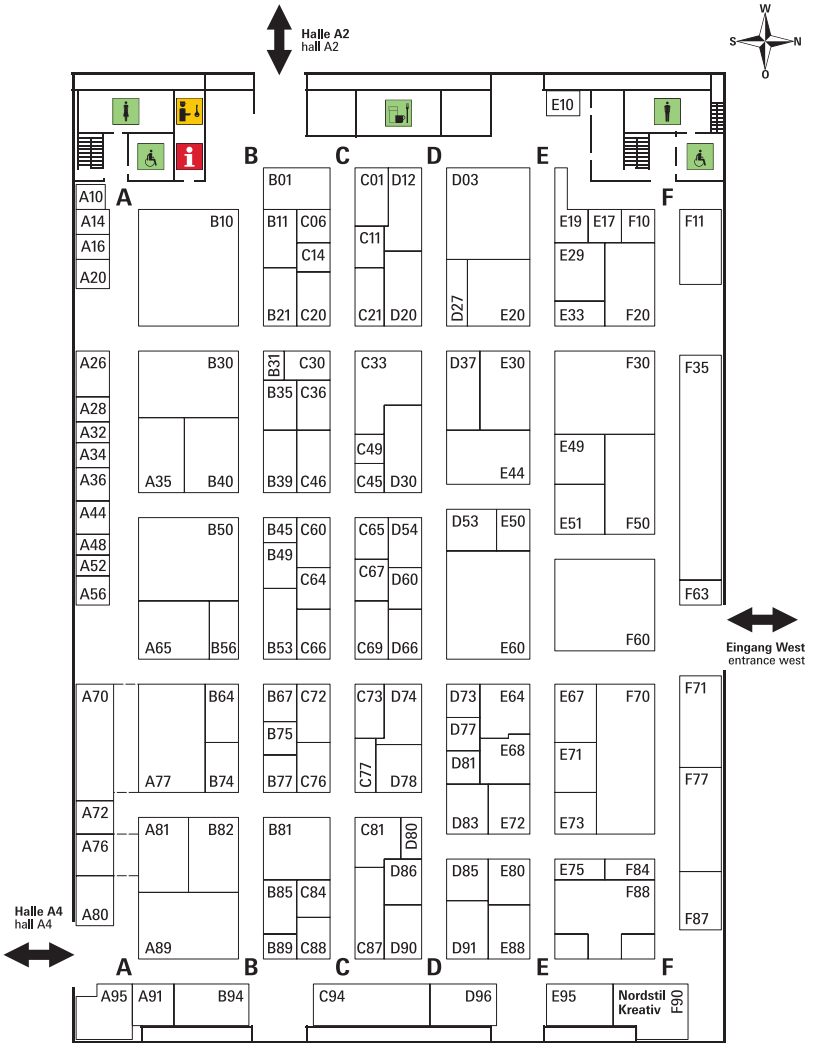

Stand 5. 12. 2017

alphabetisch

4you Design GmbH & Co. KG	A3.0 D53	Glücksschmiedin – Ulrike Alt	A3.0 A28
Acte tre Deutschland GmbH	A3.0 D20	Goldbuch Georg Brückner GmbH	A3.0 E68
AHS-Spielzeug GmbH & Co. KG	A3.0 B77	EDITION GOLLOLONG GmbH	A3.0 D37
Andrea Verlags GmbH	A3.0 D96	Grätz Verlag GmbH	A3.0 E44
Ankerherz Verlag GmbH	A3.0 C60	Grafik Werkstatt – Becker & Becker Vertrieb GmbH & Co. KG	A3.0 E60
arsEdition GmbH	A3.0 E71	Greenlife Value GmbH	A3.0 B64
Art à la Card GbR	A3.0 D74	Gutsch Verlag GmbH & Co. KG	A3.0 B01
art & nature Verlag für Naturfotografie - Antje Fleischhauer	A3.0 C94	HABA - Habermaass GmbH	A3.0 B94
Artis Design GmbH	A3.0 D91	HANSEKIND GmbH	
Atelier66	A3.0 E75	Kindermöbel & Accessoires	A3.0 C76
AvanCarte GmbH	A3.0 B50	Happy Accessories AB	A3.0 D81
bb Klostermann GmbH	A3.0 C33	Hartung GmbH & Co. KG	A3.0 E20
BeeGoodies by hellogreen GbR	A3.0 A52	BPPM Heart of Ireland GmbH	A3.0 A14
Bekking & Blitz Uitgevers B.V.	A3.0 D37	HELLMANN-VERSAND GMBH	A3.0 D03
Berk Esoterik e.K.	A3.0 F50	HERGO Creation GmbH	A3.0 E30
Gebr. Bertels		HERMA GmbH	A3.0 C06
Handelsvertretung GmbH	A3.0 E95	Herpa Miniaturmodelle GmbH	A3.0 D54
die Blechfabrik e.K.	A3.0 A95	HobbyFun GmbH & Co. KG	A3.0 F88
Bow & Hummingbird, Inh. Carolin Hennekes	A3.0 A44	holzpost GmbH	A3.0 C73
Braun + Company Papierwaren GmbH	A3.0 E95	inhoma	A3.0 E19
Breitner GmbH Kunstgewerbe	A3.0 D12	Inkognito Gesellschaft für faustdicke Überraschungen mbH	A3.0 B21
BRIO GmbH	A3.0 B67	Invento Products & Services GmbH	A3.0 D30
Brunnen-Verlag GmbH	A3.0 B35	JaBaDaBaDo-Vertretung – Deutschland – Hans-Jürgen Nitsch	A3.0 C81
meer! Karin Buchholz	A3.0 A36	Friedrich Jahncke GmbH & Co. KG	A3.0 D83
BUTT Papierkram	A3.0 D78	JOJO e.K. Inh. Joachim Kuerz	A3.0 F77
Carletto Deutschland GmbH	A3.0 A35	JURATOYS GmbH	A3.0 B85
CARLSEN Verlag GmbH	A3.0 E71	Just Gin	A3.0 A16
Casablanca GmbH & Co. KG	A3.0 A70	KCG Kawlath Creativ GmbH	A3.0 C66
Modernes Design	A3.0 A77	kerzilein GmbH	A3.0 C77
Cepewa GmbH	A3.0 F60	Gerd Koch Konzept + Handels GmbH	A3.0 B53
Charlotte Wooning V.O.F.	A3.0 A20	Winfried Kögler GmbH	A3.0 F11
cityproducts	A3.0 C87	Winfried Kögler GmbH	A3.0 F35
ColourLovers		Franckh-Kosmos Verlags-GmbH & Co. KG	A3.0 E51
Lisa Mau-Rölke - Handelsagentin	A3.0 B75	KRaejen GmbH	A3.0 C69
Coppenrath Verlag GmbH & Co. KG	A3.0 A89	Kunst und Bild GmbH	A3.0 E64
cosmic-shop Anja Jung	A3.0 A48	Die Kunstkarte	
Crazy Three GmbH	A3.0 B56	Inh. Andreas Nußberger	A3.0 D86
Creativ Company Deutschland GmbH	A3.0 E88	la Vida GmbH / Geschenk für Dich	A3.0 B30
daniels*cards	A3.0 D80	Dr. P. Lacey - Praxis für Humormedizin	A3.0 C14
Depesche Vertrieb GmbH & Co. KG	A3.0 B10	Lamberth ApS	A3.0 C45
Die Werkstatt		Lang & Schrödter Verlag	A3.0 F84
Verlagsauslieferung GmbH	A3.0 D91	Lazzaro Art e.K.	A3.0 D73
Carl Dietrich GmbH	A3.0 E80	Leif GmbH	A3.0 C84
Discordia Verlags GmbH	A3.0 C94	LienArt	A3.0 D91
efco creative GmbH	A3.0 F87	Lindauer Ludwig Lipp GmbH	
EIGENART / Studio B Glückwunschkarten GmbH	A3.0 E50	Schreibgeräte & Lesehilfen	A3.0 A91
elbhus Illustration Inh. Gisela Aguirre	A3.0 A56	Helmut Lingen Verlag GmbH	A3.0 C67
ELBUFER Inh. Oliver Binikowski	A3.0 A32	Manufaktur Locnikar GmbH & Co. KG	A3.0 C21
EPOCH Traumwiesen GmbH	A3.0 B39	Lottas Lable GmbH	A3.0 B89
eye-comm Naturfotokarten	A3.0 D91	Lutz Mauder Verlag GmbH & Co. KG	A3.0 A65
Fantasie4Kids OHG	A3.0 B74	Magdalenen Verlag	
Fantasie4Kids OHG	A3.0 B74	Clemens Kopp OHG	A3.0 D66
Fantasie4Kids OHG	A3.0 B74	Matthies Spielprodukte GmbH + Co. KG	A3.0 C64
Fantasie4Kids OHG	A3.0 B74	Peter Menk Souvenirs	
Fantasie4Kids OHG	A3.0 B74	Inh. Matthias Röhrs	A3.0 F20
Fantasie4Kids OHG	A3.0 B74	meori GmbH & Co. KG	A3.0 A10
FOND OF GmbH	A3.0 C72	MoinDori Hamburg	
Fun Unlimited Products GmbH	A3.0 C20	Brugger&Glamm GbR	A3.0 A34
GAPYRUS OHG		moses. Verlag GmbH	A3.0 B82
G. Biegert / A. Lohmann-Biegert		mt products GmbH	A3.0 A72
Buchbinderarbeiten	A3.0 C11		
Gebro B.V.	A3.0 E29		
Glorex GmbH	A3.0 E95		

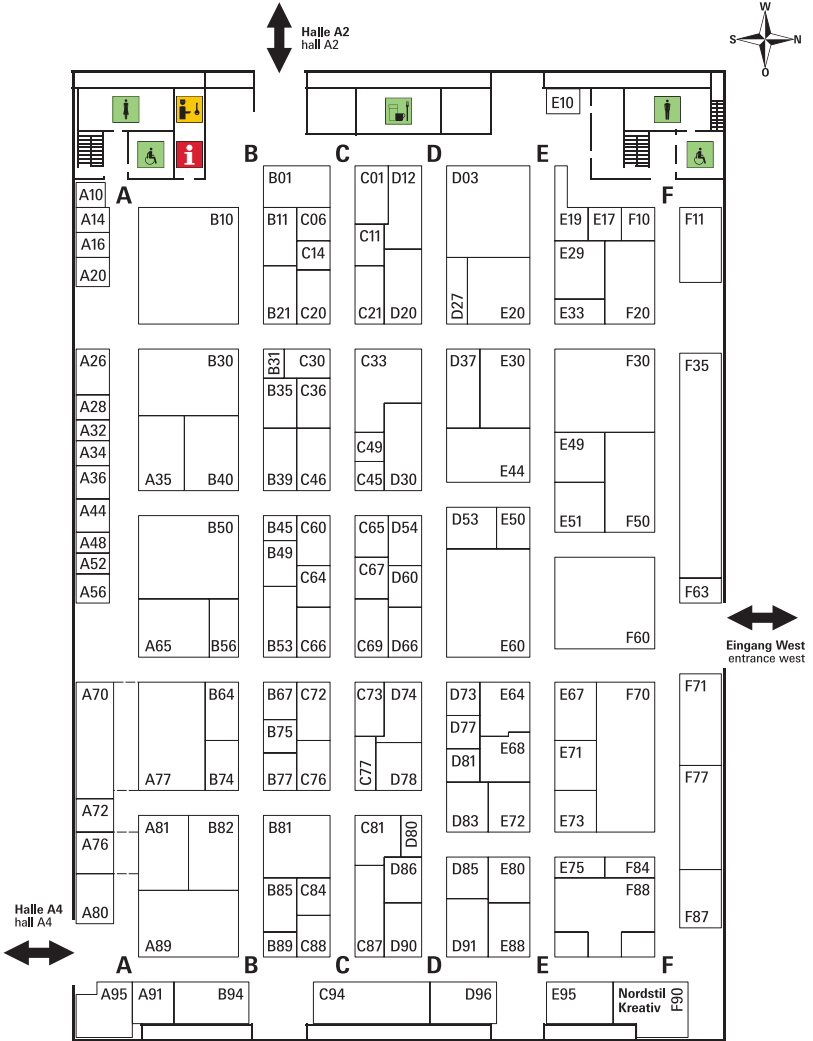

Stand 5. 12. 2017

Münchener Verlagsgruppe GmbH	A3.0 E71	Lutz Mauder Verlag GmbH & Co. KG	A3.0 A65
Opus 4 - die Geschenkartikel- Komposition Vertriebs GmbH	A3.0 B40	Casablanca GmbH & Co. KG	A3.0 A70
Out of the blue KG	A3.0 F30	Modernes Design	A3.0 A72
packart by S. Butschkat, Einzelunternehmen	A3.0 C36	mt products GmbH	A3.0 A76
Papeteria-Verlags- Unternehmensgesellschaft	A3.0 D85	RS Segelken GmbH	A3.0 A77
Papierkunst Bremen	A3.0 C30	Casablanca GmbH & Co. KG	A3.0 A80
paruspaper. nutzfeine papeterie, Heller & Camps GbR	A3.0 A80	Modernes Design	A3.0 A81
Pickmotion UG (haftungsbeschränkt)	A3.0 B45	paruspaper. nutzfeine papeterie, Heller & Camps GbR	A3.0 A89
PopShots Studios Ltd.	A3.0 C94	RS Segelken GmbH	A3.0 A89
Prisma Fachhandels AG	A3.0 E10	Coppenrath Verlag GmbH & Co. KG	A3.0 A91
ProNa GmbH	A3.0 F71	Lindauer Ludwig Lipp GmbH	A3.0 A95
Rannenberg & Friends	A3.0 F70	Schreibgeräte & Lesehilfen	A3.0 B01
RennerKarten Design Inhaber Martina Renner	A3.0 C46	die Blechfabrik e.K.	A3.0 B10
RS Segelken GmbH	A3.0 A76	Gutsch Verlag GmbH & Co. KG	A3.0 B11
RS Segelken GmbH	A3.0 A81	Depesche Vertrieb GmbH & Co. KG	A3.0 B21
Handelskontor SANUK GmbH	A3.0 E33	Tushita Verlag GmbH	A3.0 B30
T&K ScandicToys e.K.	A3.0 E72	Inkognito Gesellschaft für faustdicke Überraschungen mbH	A3.0 B31
Richard Sellmer Verlag KG	A3.0 F63	la Vida GmbH / Geschenk für Dich werke & formen Kerstin Selle	A3.0 B35
Shanghai Toys (Holland) sigikid,	A3.0 F10	Brunnen-Verlag GmbH	A3.0 B39
H. Scharrer & Koch GmbH & Co. KG	A3.0 B81	EPOCH Traumwiesen GmbH	A3.0 B40
Polanski Speckstein – Marco Polanski	A3.0 A26	Opus 4 - die Geschenkartikel- Komposition Vertriebs GmbH	A3.0 B45
Susi Winter e.K.	A3.0 D77	Pickmotion UG (haftungsbeschränkt)	A3.0 B49
TERRA Data GmbH	A3.0 E17	Manfred Werner Handelsvertretung	A3.0 B50
Thienemann-Esslinger Verlag GmbH	A3.0 E71	AvanCarte GmbH	A3.0 B53
Trötsch Verlag GmbH Co. KG	A3.0 C01	Gerd Koch Konzept + Handels GmbH	A3.0 B56
Trousselier S.A.S	A3.0 C88	Crazy Three GmbH	A3.0 B64
Tushita Verlag GmbH	A3.0 B11	Greenlife Value GmbH	A3.0 B67
United Labels AG	A3.0 E49	BRIO GmbH	A3.0 B74
Venceremos GmbH	A3.0 F71	Fantasie4Kids OHG	A3.0 B75
Voggenreiter Verlag GmbH	A3.0 D60	ColourLovers	A3.0 B77
werke & formen Kerstin Selle	A3.0 B31	Lisa Mau-Rölke - Handelsagentin	A3.0 B81
Manfred Werner Handelsvertretung	A3.0 B49	AHS-Spielzeug GmbH & Co. KG	A3.0 B82
Wolf Präsende GmbH	A3.0 C65	sigikid, H. Scharrer & Koch GmbH & Co. KG	A3.0 B85
Wrede Verpackungen GmbH	A3.0 E73	moses. Verlag GmbH	A3.0 B89
Yabué Design & Grußkartenverlag, B. Bültler	A3.0 D90	JURATOYS GmbH	A3.0 B94
YesBox GmbH	A3.0 D27	Lottas Lable GmbH	A3.0 C01
ZWITSCHERBOX / Relaxound GmbH	A3.0 C49	HABA - Habermaass GmbH	A3.0 C06

nach Standnummer

meori GmbH & Co. KG	A3.0 A10	G. Biegert / A. Lohmann-Biegert	A3.0 C11
BPPM Heart of Ireland GmbH	A3.0 A14	Buchbinderarbeiten	A3.0 C14
Just Gin	A3.0 A16	Dr. P. Lacebo - Praxis für Humormedizin	A3.0 C20
Charlotte Wooning V.O.F.	A3.0 A20	Fun Unlimited Products GmbH	A3.0 C21
Polanski Speckstein – Marco Polanski	A3.0 A26	Manufaktur Locnikar GmbH & Co. KG	A3.0 C30
Glücksschmiedin – Ulrike Alt	A3.0 A28	Papierkunst Bremen	A3.0 C33
ELBUFER Inh. Oliver Binikowski	A3.0 A32	bb Klostermann GmbH	A3.0 C36
MoinDori Hamburg		packart by S. Butschkat, Einzelunternehmen	A3.0 C45
Brugger&Glammm GbR	A3.0 A34	Lamberth ApS	A3.0 C46
Carletto Deutschland GmbH	A3.0 A35	RennerKarten Design	A3.0 C49
meer! Karin Buchholz	A3.0 A36	Inhaber Martina Renner	A3.0 C60
Bow & Hummingbird, Inh. Carolin Hennekes	A3.0 A44	ZWITSCHERBOX / Relaxound GmbH	A3.0 C64
cosmic-shop Anja Jung	A3.0 A48	Ankerherz Verlag GmbH	A3.0 C65
BeeGoodies by hellogreen GbR	A3.0 A52	Matthies Spielprodukte GmbH + Co. KG	A3.0 C66
elbhus Illustration Inh. Gisela Aguirre	A3.0 A56	Wolf Präsende GmbH	A3.0 C67
		KCG Kawlath Creativ GmbH	A3.0 C69
		Helmut Lingen Verlag GmbH	
		KRaejen GmbH	

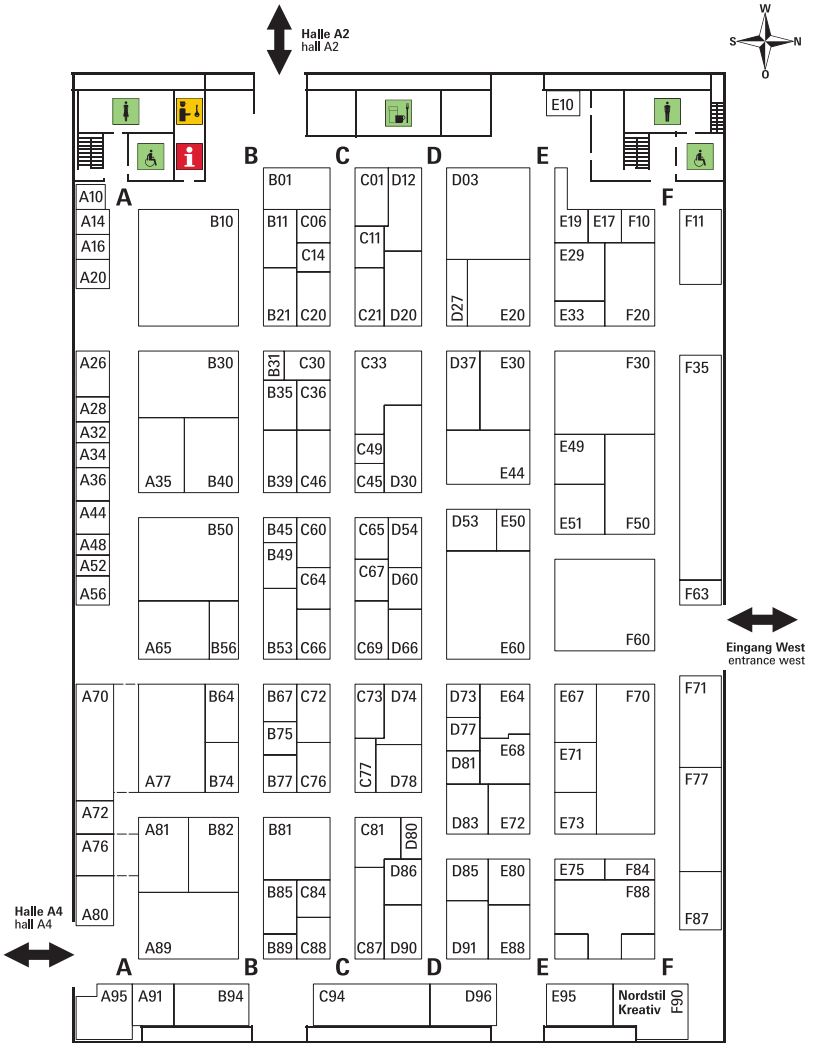

Stand 5. 12. 2017

FOND OF GmbH	A3.0 C72	Münchener Verlagsgruppe GmbH	A3.0 E71
holzpost GmbH	A3.0 C73	Thienemann-Esslinger Verlag GmbH	A3.0 E71
HANSEKIND GmbH		T&K ScandicToys e.K.	A3.0 E72
Kindermöbel & Accessoires	A3.0 C76	Wrede Verpackungen GmbH	A3.0 E73
kerzleIn GmbH	A3.0 C77	Atelier66	A3.0 E75
JaBaDaBaDo-Vertretung – Deutschland – Hans-Jürgen Nitsch	A3.0 C81	Carl Dietrich GmbH	A3.0 E80
Leif GmbH	A3.0 C84	Creativ Company Deutschland GmbH	A3.0 E88
cityproducts	A3.0 C87	Gebr. Bertels Handelsvertretung GmbH	A3.0 E95
Trousselier S.A.S	A3.0 C88	Braun + Company Papierwaren GmbH	A3.0 E95
art & nature Verlag für Naturfotografie - Antje Fleischhauer	A3.0 C94	Glorex GmbH	A3.0 E95
Discordia Verlags GmbH	A3.0 C94	Shanghai Toys (Holland)	A3.0 F10
PopShots Studios Ltd.	A3.0 C94	Winfried Kögler GmbH	A3.0 F11
HELLMANN-VERSAND GMBH	A3.0 D03	Peter Menk Souvenirs	
Breitner GmbH Kunstgewerbe	A3.0 D12	Inh. Matthias Röhrs	A3.0 F20
Acte tre Deutschland GmbH	A3.0 D20	Out of the blue KG	A3.0 F30
YesBox GmbH	A3.0 D27	Winfried Kögler GmbH	A3.0 F35
Invento Products & Services GmbH	A3.0 D30	Berk Esoterik e.K.	A3.0 F50
Bekking & Blitz Uitgevers B.V.	A3.0 D37	Cepewa GmbH	A3.0 F60
EDITION GOLLONG GmbH	A3.0 D37	Richard Sellmer Verlag KG	A3.0 F63
4you Design GmbH & Co. KG	A3.0 D53	Rannenberg & Friends	A3.0 F70
Herpa Miniaturmodelle GmbH	A3.0 D54	ProNa GmbH	A3.0 F71
Voggenreiter Verlag GmbH	A3.0 D60	Venceremos GmbH	A3.0 F71
Magdalenen Verlag		JOJO e.K. Inh. Joachim Kuerz	A3.0 F77
Clemens Kopp OHG	A3.0 D66	Lang & Schrödter Verlag	A3.0 F84
Lazzaro Art e.K.	A3.0 D73	efco creative GmbH	A3.0 F87
Art à la Card GbR	A3.0 D74	HobbyFun GmbH & Co. KG	A3.0 F88
Susi Winter e.K.	A3.0 D77		
BUTT Papierkram	A3.0 D78		
daniels*cards	A3.0 D80		
Happy Accessories AB	A3.0 D81		
Friedrich Jahncke GmbH & Co. KG	A3.0 D83		
Papeteria-Verlags- Unternehmergesellschaft	A3.0 D85		
Die Kunstkarte			
Inh. Andreas Nußberger	A3.0 D86		
Yabué Design & Grußkartenverlag, B. Bültler	A3.0 D90		
Artis Design GmbH	A3.0 D91		
Die Werkstatt			
Verlagsauslieferung GmbH	A3.0 D91		
eye-comm Naturfotokarten	A3.0 D91		
LienArt	A3.0 D91		
Andrea Verlags GmbH	A3.0 D96		
Prisma Fachhandels AG	A3.0 E10		
TERRA Data GmbH	A3.0 E17		
inhoma	A3.0 E19		
Hartung GmbH & Co. KG	A3.0 E20		
Gebro B.V.	A3.0 E29		
HERGO Creation GmbH	A3.0 E30		
Handelskontor SANUK GmbH	A3.0 E33		
Grätz Verlag GmbH	A3.0 E44		
United Labels AG	A3.0 E49		
EIGENART / Studio B			
Glückwunschkarten GmbH	A3.0 E50		
Franckh-Kosmos Verlags-GmbH & Co. KG	A3.0 E51		
Grafik Werkstatt – Becker & Becker Vertrieb GmbH & Co. KG	A3.0 E60		
Kunst und Bild GmbH	A3.0 E64		
FantasTick Greetings GmbH	A3.0 E67		
Goldbuch Georg Brückner GmbH	A3.0 E68		
arsEdition GmbH	A3.0 E71		
CARLSEN Verlag GmbH	A3.0 E71		

Halle A4 Hall A4

Stil & Design
Style & Design

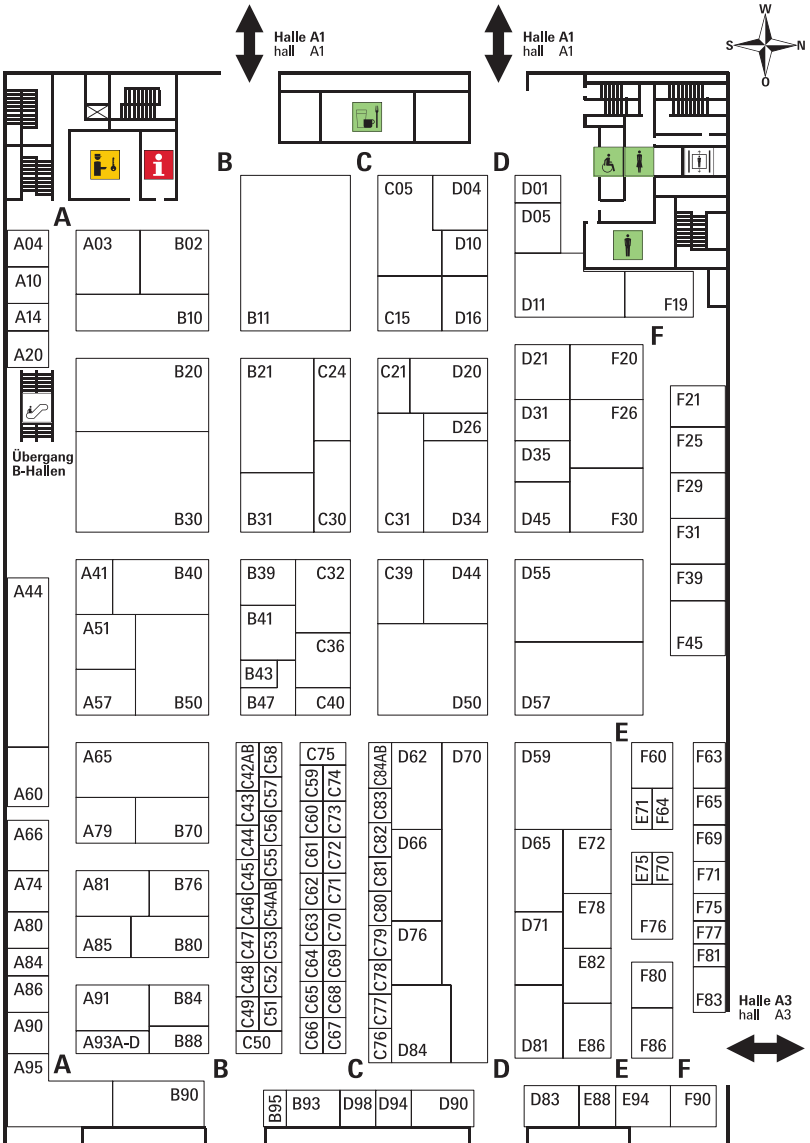

Stand 5. 12. 2017

alphabetisch

360° Segeltuchtaschen – Taschenagentur Kramer e.U.	A4.0 D94	Funky Doris AS	A4.0 A93A
Acufactum Ute Menze	A4.0 B84	Familie von Quast – FvQ GmbH	A4.0 D45
Anna Cosma	A4.0 C42A	GGT PLUS GmbH	A4.0 C69
ANOTHER ME	A4.0 A51	Gift Company	
ARTEBENE GmbH	A4.0 B40	Geschenke Vertriebs GmbH	A4.0 D59
AsianSpirit	A4.0 A91	Good old friends GmbH	A4.0 D84
Aspegren Denmark	A4.0 B39	Greenbomb	A4.0 A51
AU Maison A/S	A4.0 C05	größereffetterbreiter	
ava&yves GmbH	A4.0 C15	Dipl.-Ing Anna Pischl	A4.0 D35
AVRILLO, Inh. Sandra Leibner	A4.0 A14	Hanne Gutbrod Wohntextil e. Kfr.	A4.0 F69
BATELA 1991 S.L.	A4.0 A44	HANDBRILLE by TOM+HATTY	A4.0 C70
BEAD GmbH	A4.0 E86	Handelskompagniet - Henrik Steen A/S	A4.0 D11
Made by BENT	A4.0 C65	HEYHOME – Kai Berger	A4.0 A41
BIMBESBOX,		houseproud GmbH	A4.0 A66
Alexander Kempe & Nils Marz GbR	A4.0 C60	Hübsch A/S	A4.0 B20
blackmoon	A4.0 C84A	IB Laursen Ribe ApS	A4.0 B11
Blossify.com / Huiskamer geluk V.O.F.	A4.0 D04	IOPLA – Indra Ohlemutz Platten	A4.0 D26
Susanne Boerner		KEINE SCHWESTER GmbH	A4.0 C78
GuteMiene/art-work/metal-work/edition	A4.0 A65	Kikisoso – Fine Paper Goods	A4.0 C42B
BOUBOUKI individual.interior.items	A4.0 A20	Kikkerland Europe B.V.	A4.0 C30
Boxiland GmbH	A4.0 C44	Kila-Photography	A4.0 E75
Bredemeijer Group B.V.	A4.0 B88	Kinta c.v.	A4.0 F19
BULL&HUNT Company	A4.0 C40	Klein & More (Klein AG)	A4.0 E72
Bulla-Manufaktur für schöne Dinge		kommod GmbH	A4.0 A10
Moritz Hornbostel	A4.0 C66	koziol »ideas for friends GmbH	A4.0 D81
By May Stockholm	A4.0 A93B	Kreafunk ApS	A4.0 D83
Candelize	A4.0 C64	krima & isa GmbH	A4.0 B90
Nelly Castro	A4.0 F25	Kuni	A4.0 F81
cats on apple trees		Kylskapspoesi AB	A4.0 B76
Gebert / Heidrich / Heidrich GbR	A4.0 D10	Lanco Ducks	A4.0 F31
CEDON MuseumShops GmbH	A4.0 D66	dorothee lehnen GmbH	A4.0 C39
Ceramiche Virginia S.r.l.	A4.0 A57	Johannes Lerch	A4.0 C71
CHI CHI FAN Hamburg	A4.0 D05	Leuchtsterncompagnie	A4.0 C43
chic.mic GmbH	A4.0 F30	Leuchtturm	
COCOLOU Claire Severloh	A4.0 B43	Albenverlag GmbH & Co. KG Semikolon	A4.0 B41
COKOE – Cornelia Köhler	A4.0 F70	LIEBESKUMMERPILLEN GmbH	A4.0 B31
Cup+Mug Company GmbH	A4.0 A85	LIEBblingsSTÜCKE by Martina Wodke	A4.0 A60
dekoop GmbH	A4.0 C21	Liebman Design Import e.K.	A4.0 D16
Design Emma Sjödin	A4.0 C52	liix Inh. Marcel Jansen	A4.0 A74
diboni GmbH	A4.0 F29	Liv Interior GmbH	A4.0 B02
Die Stadtgärtner Inh. Derk Niemeijer	A4.0 E82	Living by colors	A4.0 B70
Donkey Products GmbH & Co. KG	A4.0 D65	Lockengelöt	
dot aarhus	A4.0 C48	Dennis Schnellting & Carsten Trill	A4.0 C59
DUKTA Leathergoods	A4.0 C81	LOUIS & LOUISA	
DutZ collection by Nethroma BV	A4.0 B21	Handelsagentur Bornemann	A4.0 E94
eDITION GUTE GEISTER	A4.0 F75	Love Objects by Justin Landon	A4.0 A04
Edition NOTO GmbH	A4.0 C76	loveS hamburg Thies & Jung GbR	A4.0 C54B
Embacollage A/S	A4.0 B80	Luca Kayz by perfect belt GmbH	A4.0 B47
Etiket	A4.0 C49	Lütt Stina illustration & design	
Eulenschnitt	A4.0 C36	Christiane Schmidt	A4.0 F39
Eurotex v/Marianne Jensen	A4.0 D21	Mademoiselle Dimanche	A4.0 A93C
Peter Ewert Handelsagentur	A4.0 B10	MAGS Vertriebs GmbH	A4.0 C31
FIFTYEIGHT 3D GmbH	A4.0 F63	Maileg ApS	A4.0 A03
FLSK Products GmbH	A4.0 A51	MARK'S EUROPE SARL	A4.0 D20
Formes Berlin		Horst Meier + Stefan Koch Spiel- und Designobjekte Modellentwicklung GbR	A4.0 B95
Nick Rübesamen Henrike Mayer GbR	A4.0 F86	MeterMorphosen GmbH	A4.0 A80
Frau Schnobel Grafik		mintkind woydt & Woydt GbR	A4.0 E71
Inh. Martina Olonschek	A4.0 C45	Mossapour Interior Designs OHG	A4.0 B50
excessories freudenschmuck		My Pretty Circus	A4.0 C47
Düsseldorf – Marion Schuster	A4.0 C74	NaSoNogo by Sonja Göggelmann	A4.0 C77
Frohstoff Meike Marie Buchholz	A4.0 F45	Nedelmann	A4.0 C24
		Neptungeschmeide	A4.0 F71
		Ninelives Inh. Helena Rahikainen	A4.0 F77

Halle A4 Hall A4

Stil & Design
Style & Design

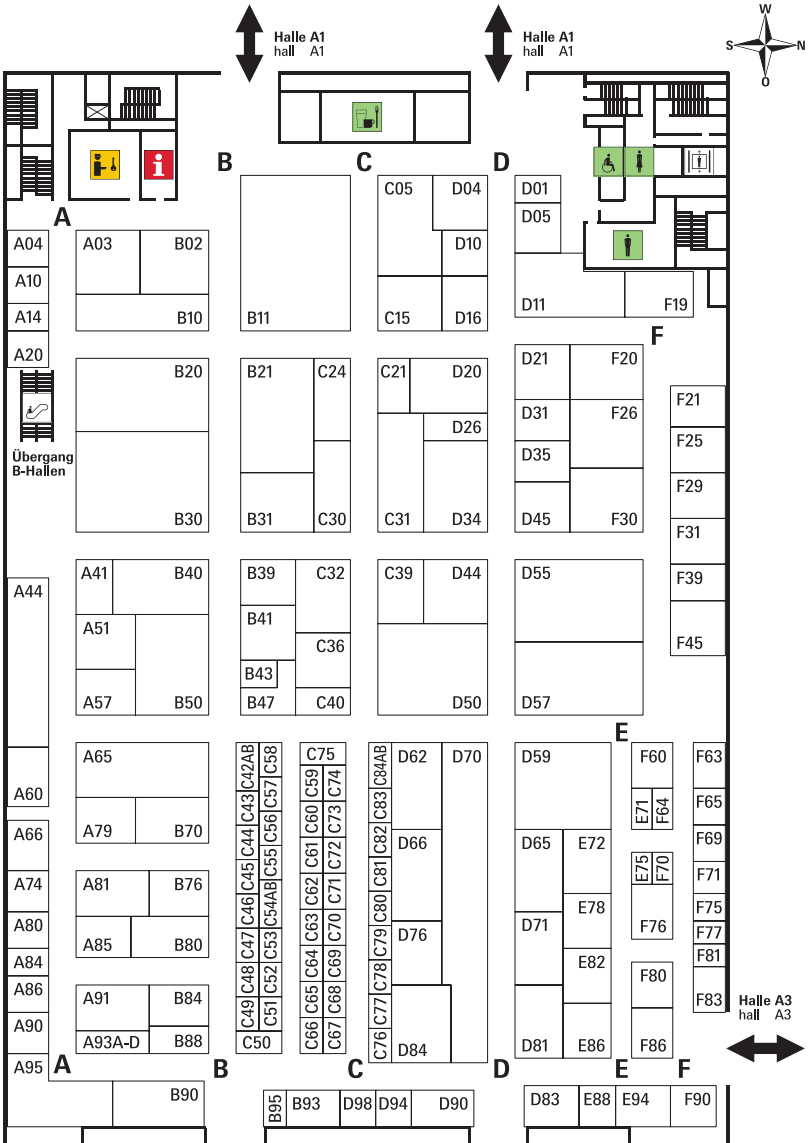

Stand 5. 12. 2017

NOGALLERY –		Trendagentur Sven Zabel	A4.0 F80
Rosenkranz & Burgmann GbR	A4.0 D76	Zawadi Claudia Liebetanz	A4.0 C72
Noi Hamburg Scherer Voigt GbR	A4.0 C32	Zell.Stoff STUDIO, Ute Linck-Borys	A4.0 C67
Nordal A/S	A4.0 B30	ZHE Online	A4.0 F90
NordernArt	A4.0 C51	MZ Vertriebsagentur CDH	
Nordic Design		Manfred Zilleßen	A4.0 A90
Inh. Marianne Leveringhaus e.K	A4.0 A81		
not the girl who misses much oHG	A4.0 F60		
nuukk	A4.0 C61		
Pad home design concept GmbH	A4.0 D55		
Paperproducts Design GmbH	A4.0 D71		
papouts! !	A4.0 F65		
Paprcuts.de, Nils Wagner	A4.0 D31		
Pechkeks GmbH	A4.0 B31		
PHILIPPI	A4.0 D62		
PHILIPPI	A4.0 D70		
Thomas Poganitsch	A4.0 C63		
Present Time Skandinavien			
v/Birger Nielse	A4.0 F20		
Puffs Brause UG (haftungsbeschränkt)	A4.0 A51		
PYTT Living ApS	A4.0 A93D		
Räder GmbH	A4.0 D50		
Raumgestalt GmbH	A4.0 D90		
Reisensthal Accessoires GmbH & Co. KG	A4.0 D57		
ROEE René Pomberger Design	A4.0 C75		
Salon Elfi - Verena Schätzlein	A4.0 D98		
SANTOKKI	A4.0 E88		
Schäkel & Schedivy GbR -			
Brennholz Design	A4.0 C62		
Die Schlöffelbänder - Marko Schlöffel	A4.0 D10		
Eva Schreiber GmbH & Co. KG	A4.0 C24		
Stand der Dinge Schulz + Stange GbR	A4.0 D01		
Seemannslicht GbR	A4.0 F64		
SeifenDealer Inh: Bettina Piel	A4.0 C55		
Simply Flowers	A4.0 C50		
Sophieplus Inh. Sarah Kinard	A4.0 A84		
soulproducts GmbH	A4.0 C53		
Space Wallet GbR Seppour & Groo	A4.0 C80		
Spruchketten by Lieblichkeiten GmbH	A4.0 A86		
Steinhöringer Werkstätten –			
Katholische Jugendfürsorge	A4.0 A95		
Studio am Meer OHG	A4.0 F76		
Handelsagentur Maik Thesing /			
bahne & co / Miss Etoile	A4.0 D34		
tinéba	A4.0 F83		
TRANQUILLO GmbH	A4.0 D44		
Trendklunker	A4.0 C73		
Tudi Billo OHG	A4.0 B93		
Typewine Inh. Michael Kijac	A4.0 C54A		
Agentur Anna Upleger GmbH & Co. KG	A4.0 A95		
USE, Union Sozialer			
Einrichtungen gemeinnützige GmbH	A4.0 E78		
Växbo Lin AB	A4.0 C79		
Jennifer van Rooyen GRAFIKDESIGN	A4.0 C46		
VENTO Vertriebs GmbH	A4.0 A79		
Villa Collection Denmark	A4.0 F26		
Peter de Vries design	A4.0 C84B		
Gazur / Waks & Sharet GbR	A4.0 C82		
Wallum – Your New Slim Wallet	A4.0 C57		
Weathergoods AB	A4.0 C68		
WIESNROCKER	A4.0 C56		
WILD at Art Design - Birgit Bertz	A4.0 C58		
Wildlife Garden AB	A4.0 F21		
woodcardz UG (haftungsbeschränkt)	A4.0 A91		

Halle A4 Hall A4

Stil & Design
Style & Design

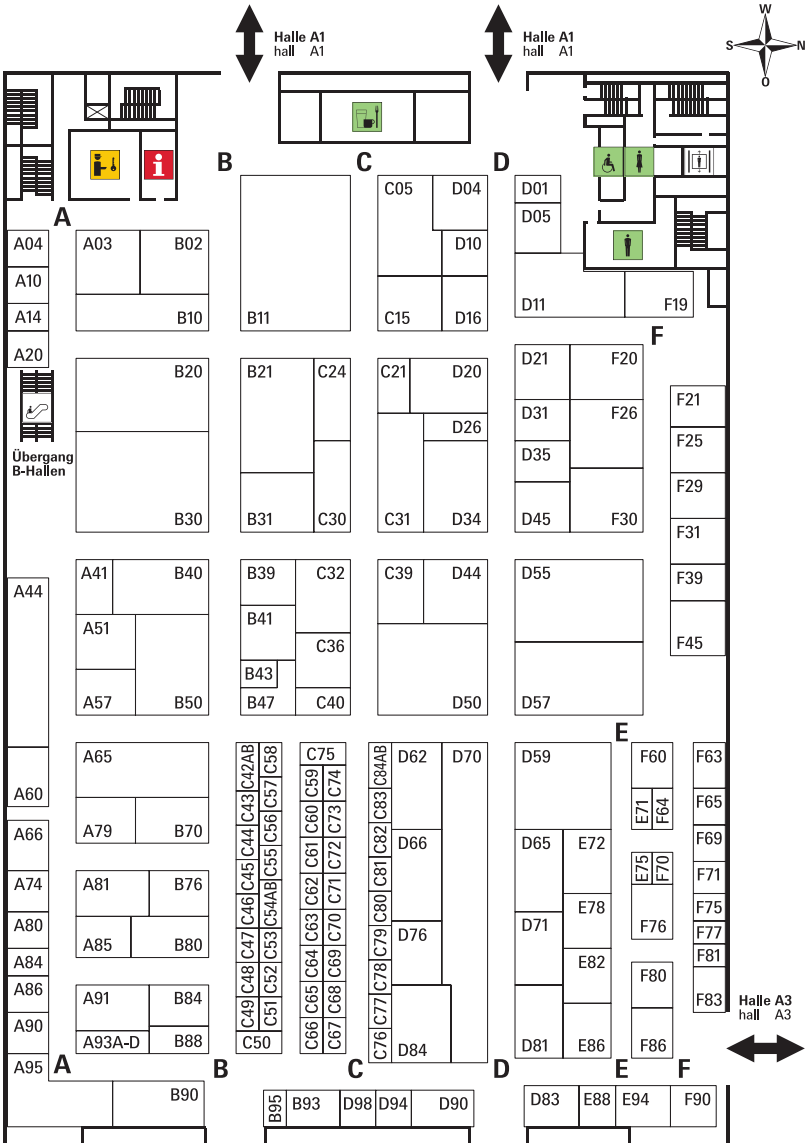

Stand 5. 12. 2017

nach Standnummer

Maileg ApS	A4.0 A03	dekoop GmbH	A4.0 C21
Love Objects by Justin Landon	A4.0 A04	Nedelmann	A4.0 C24
kommod GmbH	A4.0 A10	Eva Schreiber GmbH & Co. KG	A4.0 C24
AVRILLO, Inh. Sandra Leibner	A4.0 A14	Kikkerland Europe B.V.	A4.0 C30
BOUBOUKI individual.interior.items	A4.0 A20	MAGS Vertriebs GmbH	A4.0 C31
HEYHOME – Kai Berger	A4.0 A41	Noi Hamburg Scherer Voigt GbR	A4.0 C32
BATELA 1991 S.L.	A4.0 A44	Eulenschnitt	A4.0 C36
ANOTHER ME	A4.0 A51	dorothee lehnen GmbH	A4.0 C39
FLSK Products GmbH	A4.0 A51	BULL&HUNT Company	A4.0 C40
Greenbomb	A4.0 A51	Anna Cosma	A4.0 C42A
Puffs Brause UG (haftungsbeschränkt)	A4.0 A51	Kikisoso – Fine Paper Goods	A4.0 C42B
Ceramiche Virginia S.r.l.	A4.0 A57	Leuchtsterncompagnie	A4.0 C43
LIEBlingsSTÜCKE		Boxiland GmbH	A4.0 C44
by Martina Wodke	A4.0 A60	Frau Schnobel Grafik	
Susanne Boerner		Inh. Martina Olonschek	A4.0 C45
GuteMiene/art-work/metal-work/edition	A4.0 A65	Jennifer van Rooyen GRAFIKDESIGN	A4.0 C46
houseproud GmbH	A4.0 A66	My Pretty Circus	A4.0 C47
liix Inh. Marcel Jansen	A4.0 A74	dot aarhus	A4.0 C48
VENTO Vertriebs GmbH	A4.0 A79	Etiket	A4.0 C49
MeterMorphosen GmbH	A4.0 A80	Simply Flowers	A4.0 C50
Nordic Design		NordernArt	A4.0 C51
Inh. Marianne Leveringhaus e.K	A4.0 A81	Design Emma Sjödin	A4.0 C52
Sophieplus Inh. Sarah Kinard	A4.0 A84	soulproducts GmbH	A4.0 C53
Cup+Mug Company GmbH	A4.0 A85	Typewine Inh. Michael Kijac	A4.0 C54A
Spruchketten by Lieblichkeiten GmbH	A4.0 A86	loveS hamburg Thies & Jung GbR	A4.0 C54B
MZ Vertriebsagentur CDH		SeifenDealer Inh: Bettina Piel	A4.0 C55
Manfred Zilleßen	A4.0 A90	WIESNRÖCKER	A4.0 C56
AsianSpirit	A4.0 A91	Wallum – Your New Slim Wallet	A4.0 C57
woodcardz UG (haftungsbeschränkt)	A4.0 A91	WILD at Art Design - Birgit Bertz	A4.0 C58
Funky Doris AS	A4.0 A93A	Lockengelöt	
By May Stockholm	A4.0 A93B	Dennis Schnelting & Carsten Trill	A4.0 C59
Mademoiselle Dimanche	A4.0 A93C	BIMBESBOX,	
PYTT Living ApS	A4.0 A93D	Alexander Kempe & Nils Marz GbR	A4.0 C60
Steinhöringer Werkstätten –		nuukk	A4.0 C61
Katholische Jugendfürsorge	A4.0 A95	Schäkel & Schediwy GbR -	
Agentur Anna Upleger GmbH & Co. KG	A4.0 A95	BrennHolz Design	A4.0 C62
Liv Interior GmbH	A4.0 B02	Thomas Poganitsch	A4.0 C63
Peter Ewert Handelsagentur	A4.0 B10	Candelize	A4.0 C64
IB Laursen Ribe ApS	A4.0 B11	Made by BENT	A4.0 C65
Hübsch A/S	A4.0 B20	Bulla-Manufaktur für schöne Dinge	
DutZ collection by Nethroma BV	A4.0 B21	Moritz Hornbostel	A4.0 C66
Nordal A/S	A4.0 B30	Zell. Stoff STUDIO, Ute Linck-Borys	A4.0 C67
Liebeskummerpillen GmbH	A4.0 B31	Weathergoods AB	A4.0 C68
Pechkeks GmbH	A4.0 B31	GGT PLUS GmbH	A4.0 C69
Aspegren Denmark	A4.0 B39	HANDBRILLE by TOM+HATTY	A4.0 C70
ARTEBENE GmbH	A4.0 B40	Johannes Lerch	A4.0 C71
Leuchtturm		Zawadi Claudia Liebetanz	A4.0 C72
Albenverlag GmbH & Co. KG Semikolon	A4.0 B41	Trendklunker	A4.0 C73
COCOLOU Claire Severloh	A4.0 B43	excessories freudenschmuck	
Luca Kayz by perfect belt GmbH	A4.0 B47	Düsseldorf – Marion Schuster	A4.0 C74
Mossapour Interior Designs OHG	A4.0 B50	ROEE René Pomberger Design	A4.0 C75
Living by colors	A4.0 B70	Edition NOTO GmbH	A4.0 C76
Kylskapsposi AB	A4.0 B76	NaSoNgo by Sonja Göggelmann	A4.0 C77
Embacollage A/S	A4.0 B80	KEINE SCHWESTER GmbH	A4.0 C78
Acufactum Ute Menze	A4.0 B84	Växbo Lin AB	A4.0 C79
Bredemeijer Group B.V.	A4.0 B88	Space Wallet GbR Seppour & Groo	A4.0 C80
krima & isa GmbH	A4.0 B90	DUKTA Leathergoods	A4.0 C81
Tudi Billo OHG	A4.0 B93	Gazur / Waks & Sharet GbR	A4.0 C82
Horst Meier + Stefan Koch Spiel- und		blackmoon	A4.0 C84A
Designobjekte Modellentwicklung GbR	A4.0 B95	Peter de Vries design	A4.0 C84B
AU Maison A/S	A4.0 C05	Stand der Dinge Schulz + Stange GbR	A4.0 D01
ava&yves GmbH	A4.0 C15	Blossify.com / Huiskamergeluk V.O.F.	A4.0 D04
		CHI CHI FAN Hamburg	A4.0 D05

Halle A4 Hall A4

Stil & Design
Style & Design

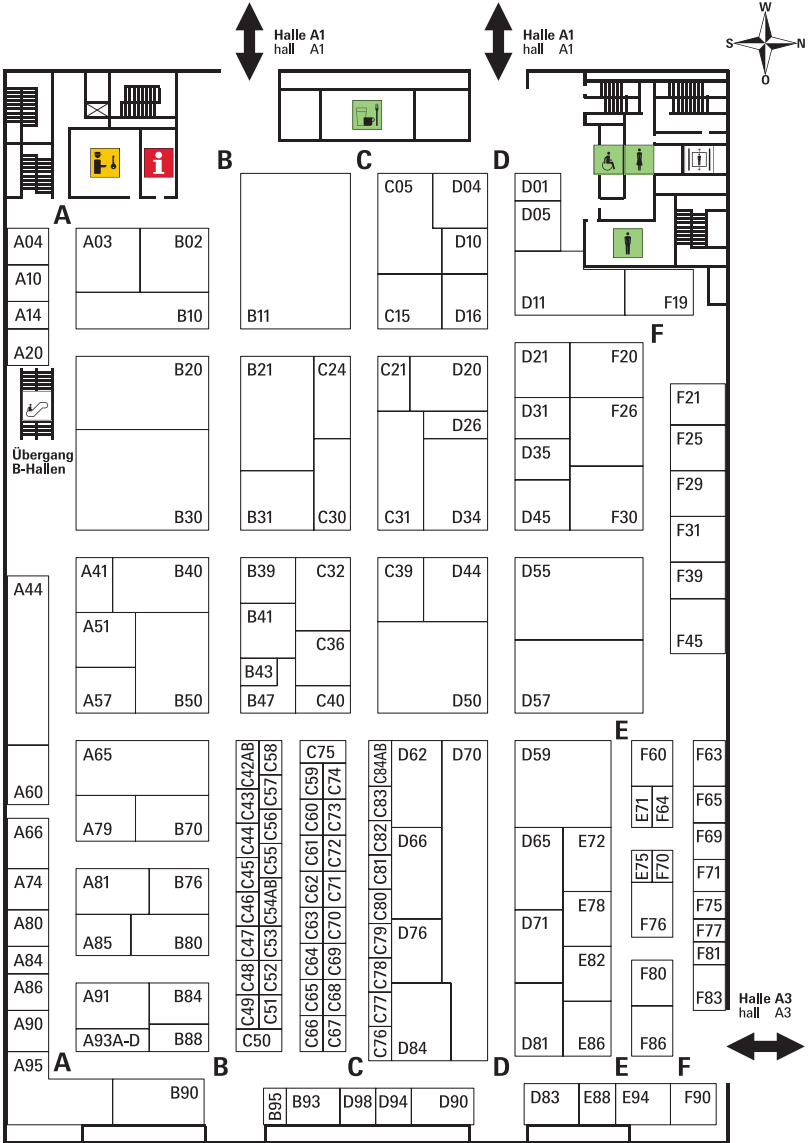

Stand 5. 12. 2017

cats on appletrees		Ninelives Inh. Helena Rahikainen	A4.0 F77
Gebert / Heidner / Heidrich GbR	A4.0 D10	Trendagentur Sven Zabel	A4.0 F80
Die Schließelbänder - Marko Schließel	A4.0 D10	Kuni	A4.0 F81
Handelskompagniet - Henrik Steen A/S	A4.0 D11	tinéba	A4.0 F83
Liebman Design Import e.K.	A4.0 D16	Formes Berlin	
MARK'S EUROPE SARL	A4.0 D20	Nick Rübesamen Henrike Mayer GbR	A4.0 F86
Eurotex v/Marianne Jensen	A4.0 D21	ZHE Online	A4.0 F90
IOPLA - Indra Ohlemutz Platten	A4.0 D26		
Paprcuts.de, Nils Wagner	A4.0 D31		
Handelsagentur Maik Thesing / bahne & co / Miss Etoile	A4.0 D34		
größerefetterbreiter			
Dipl.-Ing Anna Pischl	A4.0 D35		
TRANQUILLO GmbH	A4.0 D44		
Familie von Quast - FvQ GmbH	A4.0 D45		
Räder GmbH	A4.0 D50		
Pad home design concept GmbH	A4.0 D55		
Reisenthal Accessoires GmbH & Co. KG	A4.0 D57		
Gift Company			
Geschenke Vertriebs GmbH	A4.0 D59		
PHILIPPI	A4.0 D62		
Donkey Products GmbH & Co. KG	A4.0 D65		
CEDON MuseumShops GmbH	A4.0 D66		
PHILIPPI	A4.0 D70		
Paperproducts Design GmbH	A4.0 D71		
NOGALLERY -			
Rosenkranz & Burgmann GbR	A4.0 D76		
koziol »ideas for friends GmbH	A4.0 D81		
Kreatfunk ApS	A4.0 D83		
Good old friends GmbH	A4.0 D84		
Raumgestalt GmbH	A4.0 D90		
360° Segeltuchtaschen - Taschenagentur Kramer e.U.	A4.0 D94		
Salon Elfi - Verena Schätzlein	A4.0 D98		
mintkind woydt & Woydt GbR	A4.0 E71		
Klein & More (Klein AG)	A4.0 E72		
Kila-Photography	A4.0 E75		
USE, Union Sozialer Einrichtungen gemeinnützige GmbH	A4.0 E78		
Die Stadtgärtner Inh. Derk Niemeijer	A4.0 E82		
BEAD GmbH	A4.0 E86		
SANTOKKI	A4.0 E88		
LOUIS & LOUISA			
Handelsagentur Bornemann	A4.0 E94		
Kinta c.v.	A4.0 F19		
Present Time Skandinavien v/Birger Nielse	A4.0 F20		
Wildlife Garden AB	A4.0 F21		
Nelly Castro	A4.0 F25		
Villa Collection Denmark	A4.0 F26		
diboni GmbH	A4.0 F29		
chic.mic GmbH	A4.0 F30		
Lanco Ducks	A4.0 F31		
Lütt Stina illustration & design			
Christiane Schmidt	A4.0 F39		
Frohstoff Meike Marie Buchholz	A4.0 F45		
not the girl who misses much oHG	A4.0 F60		
FIFTYEIGHT 3D GmbH	A4.0 F63		
Seemannslicht GbR	A4.0 F64		
papouts! !	A4.0 F65		
Hanne Gutbrod Wohntextil e. Kfr.	A4.0 F69		
COKOE - Cornelia Köhler	A4.0 F70		
Neptungeschmeide	A4.0 F71		
eDITION GUTE GEISTER	A4.0 F75		
Studio am Meer OHG	A4.0 F76		

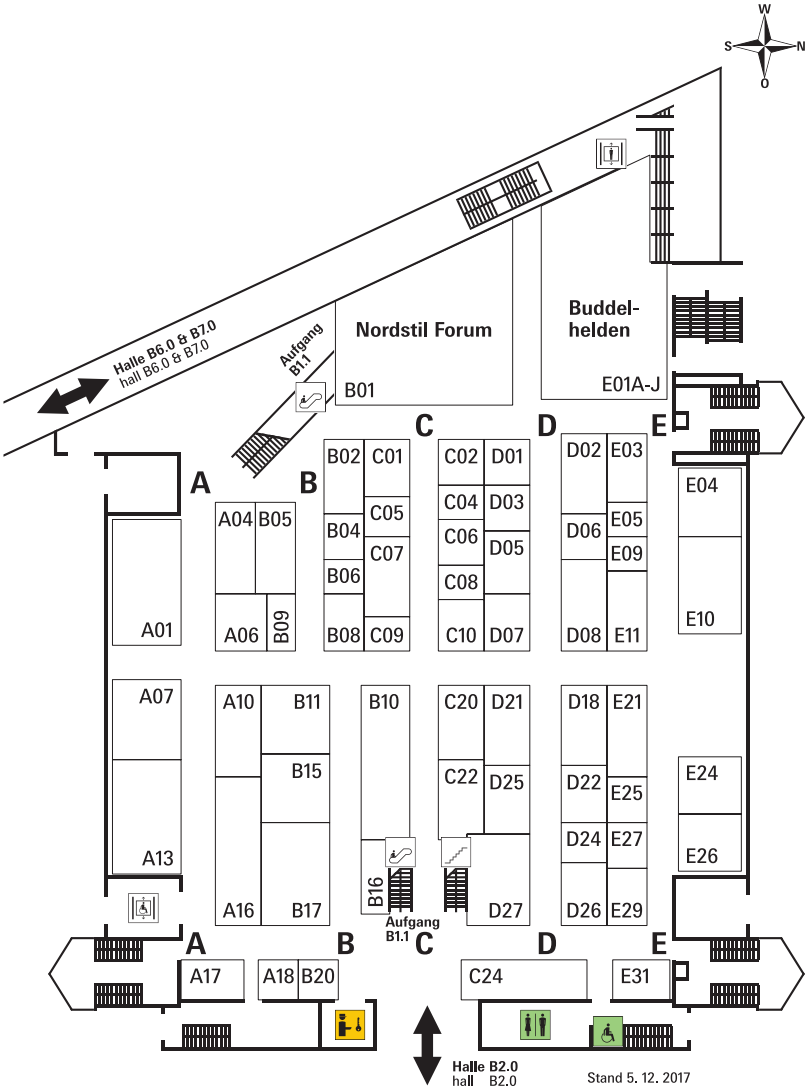

alphabetisch

0815 Extrem Gut - Axel Hadulla	B1.0 E01C	Müller & Lapurina GbR	B1.0 C05
Action Sports GmbH	B1.0 A17	MyCupOfTea GmbH	B1.0 E03
AdHoc Entwicklung und Vertrieb GmbH	B1.0 A06	Nusswerk GmbH	B1.0 A04
Ahland Handelsagentur oHG	B1.0 C24	O'Donnell Moonshine GmbH	B1.0 A10
Amodeo Food GmbH	B1.0 B20	Patrizia GmbH	B1.0 C20
AMORE SWEETS GmbH	B1.0 B08	Pi Tea GmbH	B1.0 E25
avita Handels GmbH	B1.0 E21	Pödör Premium Öle und Essige	B1.0 C06
Naturmittel Biller	B1.0 A07	Puffs Brause UG (haftungsbeschränkt)	B1.0 A10
Brainstream GmbH	B1.0 C02	Rosengarten am Deich	
Christine Berger GmbH & Co. KG	B1.0 E29	Sven Jacobsen	B1.0 A04
CMF-Produkte Keller	B1.0 B02	Salzwerk Berlin Annett Goldschmidt	B1.0 B04
Confiserie Paulsen Manufaktur - Biebl Handelsges. mbH	B1.0 A04	Saxonia Feinsteingeug-Manufaktur OHG	B1.0 C10
Daja Chocolate		Die Schlemmerei e.K. Genussmanufaktur	B1.0 E03
Schokoladenmanufaktur KG	B1.0 C04	Schoko-Laden GmbH	B1.0 E11
Deligreece GmbH	B1.0 B17	Spirit of Spice & Passione & Jordan Olivenöl	B1.0 D24
Delikatessenwinkel GbR	B1.0 B11	Svenja S. Collection	B1.0 E26
Dethlefsen & Balk GmbH		Tassenmann GmbH	B1.0 D01
Import-Export	B1.0 A01	Tea Goetz GmbH	B1.0 B05
Dr. Jaglas German Nature	B1.0 E01E	TEA IS FOR YOU	B1.0 E09
Feingeisterei Inh. Fabian Rohrwasser	B1.0 A04	Teehandel Wordtmann GmbH	B1.0 D06
Feuer & Glas OHG	B1.0 D27	Tomatenschmatz und Co. Gewürzmischungen aus Buxtehude	B1.0 A10
Florapharm		Veronica Danneberg	B1.0 D07
Pflanzliche Naturprodukte GmbH form & linie	B1.0 B15 B1.0 D03	Villa Masecri GmbH	B1.0 C08
Weingut Freitag	B1.0 E01F	Wein & Secco Köth GmbH	B1.0 E31
Gmeiner Confiserie & Kaffeehausunternehmen	B1.0 C01	Gebrüder Wollenhaupt GmbH	
GoldCorn GmbH	B1.0 A04	Abt. Teeland	B1.0 A16
Gourmet Berner GmbH & Co. KG	B1.0 B10	Zielonka - Wohnen & Leben GmbH	B1.0 E10
Gourmet Berner GmbH & Co. KG	B1.0 C22		
Green Light e.K.	B1.0 B16		
greenomic	B1.0 D08		
Der Gutschmecker	B1.0 E24		
H&B Handelskontor GmbH	B1.0 D05		
Hanse Tee Contor Wismar GmbH	B1.0 D25		
Havelwasser - Rafael Kugel	B1.0 A04		
Heise Original Bunzlauer	B1.0 C10		
Hoos London Gin – Heiko Hoos	B1.0 E01A		
IMV Spezialitäten-Import, Marketing & Vertriebs GmbH	B1.0 C07		
ja-unendlich GbR			
Allan und Jeannette Belter	B1.0 B09		
my-own-coffee			
Kaffeemanufaktur Ingrid Grau	B1.0 C09		
Kannegießer Keramik	B1.0 C10		
Dr. Gustav Klein GmbH & Co. KG	B1.0 E01D		
Kramer's Spezialitäten GmbH	B1.0 D21		
Lang Weinessig Event GmbH	B1.0 A18		
Lanwehr GmbH,			
Confiserie – Manufaktur	B1.0 D22		
LASSE LAKRITS – natürlich Lecker	B1.0 E27		
LatImBev GmbH	B1.0 E01G		
Laux GmbH	B1.0 A13		
Lindner Porzellanfabrik KG	B1.0 D26		
Hof Löbke GmbH & Co. KG	B1.0 D18		
Marc & Kay GmbH	B1.0 E05		
Market Grounds GmbH & Co. KG	B1.0 E04		
Maximilian Markus Hörmann	B1.0 B06		
Merkle & Biskup OHG	B1.0 D02		
Landwirtschaftliche Kornbrennerei Moosbur	B1.0 E01B		

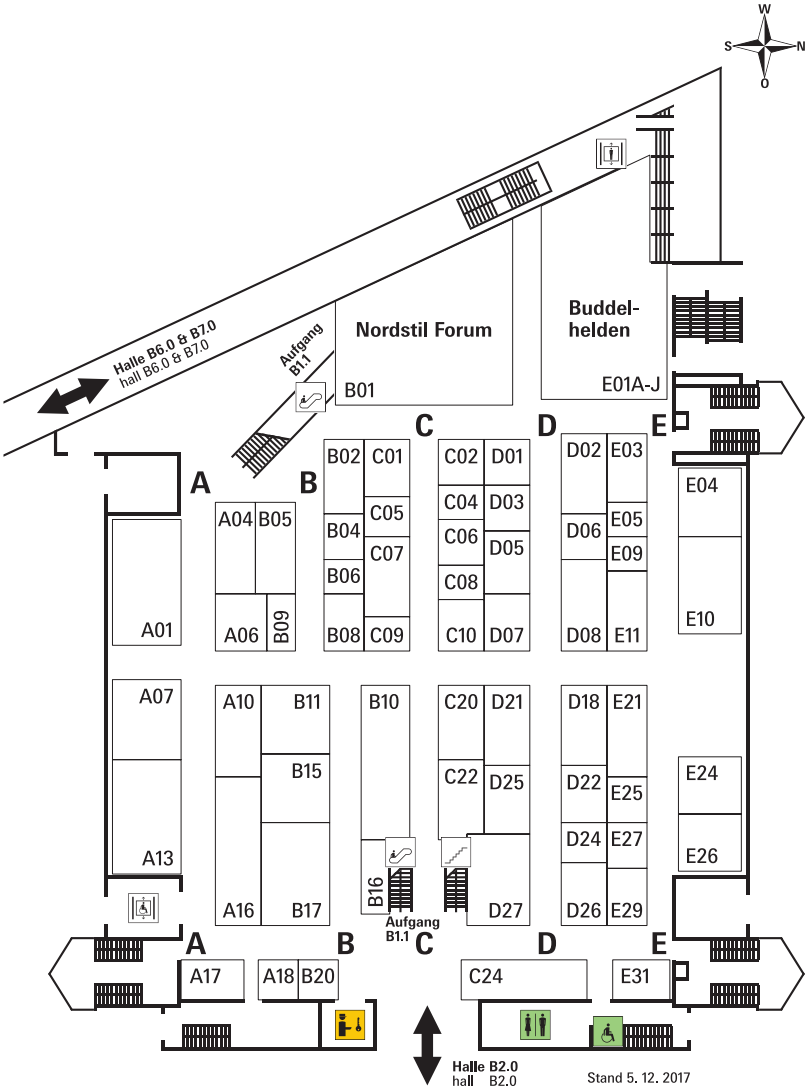

nach Standnummer

Dethlefsen & Balk GmbH Import-Export	B1.0 A01	Landwehr GmbH, Confiserie – Manufaktur	B1.0 D22
Confiserie Paulsen Manufaktur - Biebl Handelsges. mbH	B1.0 A04	Spirit of Spice & Passione & Jordan Olivenöl	B1.0 D24
Feingeisterei Inh. Fabian Rohrwasser	B1.0 A04	Hanse Tee Contor Wismar GmbH	B1.0 D25
GoldCorn GmbH	B1.0 A04	Lindner Porzellanfabrik KG	B1.0 D26
Havelwasser - Rafael Kugel	B1.0 A04	Feuer & Glas OHG	B1.0 D27
Nusswerk GmbH	B1.0 A04	Hoos London Gin – Heiko Hoos	B1.0 E01A
Rosengarten am Deich		Landwirtschaftliche Kornbrennerei Moosbur	B1.0 E01B
Sven Jacobsen	B1.0 A04	0815 Extrem Gut - Axel Hadulla	B1.0 E01C
AdHoc Entwicklung und Vertrieb GmbH	B1.0 A06	Dr. Gustav Klein GmbH & Co. KG	B1.0 E01D
Naturmittel Biller	B1.0 A07	Dr. Jaglas German Nature	B1.0 E01E
O'Donnell Moonshine GmbH	B1.0 A10	Weingut Freitag	B1.0 E01F
Puffs Brause UG (haftungsbeschränkt)	B1.0 A10	LatImBev GmbH	B1.0 E01G
Tomatenschmatz und Co. Gewürzmischungen aus Buxtehude	B1.0 A10	MyCupOfTea GmbH	B1.0 E03
Laux GmbH	B1.0 A13	Die Schlemmerei e.K. Genussmanufaktur	B1.0 E03
Gebrüder Wollenhaupt GmbH Abt. Teeland	B1.0 A16	Market Grounds GmbH & Co. KG	B1.0 E04
Action Sports GmbH	B1.0 A17	Marc & Kay GmbH	B1.0 E05
Lang Weinessig Event GmbH	B1.0 A18	TEA IS FOR YOU	B1.0 E09
CMF-Produkte Keller	B1.0 B02	Zielonka - Wohnen & Leben GmbH	B1.0 E10
Salzwerk Berlin Annett Goldschmidt	B1.0 B04	Schoko-Laden GmbH	B1.0 E11
Tea Goetz GmbH	B1.0 B05	avita Handels GmbH	B1.0 E21
Maximilian Markus Hörmann	B1.0 B06	Der Gutschmecker	B1.0 E24
AMORE SWEETS GmbH	B1.0 B08	Pi Tea GmbH	B1.0 E25
ja-unendlich GbR		Svenja S. Collection	B1.0 E26
Allan und Jeannette Belter	B1.0 B09	LASSE LAKRITS – natürlich Lecker	B1.0 E27
Gourmet Berner GmbH & Co. KG	B1.0 B10	Christine Berger GmbH & Co. KG	B1.0 E29
Delikatessenwinkel GbR	B1.0 B11	Wein & Secco Köth GmbH	B1.0 E31
Florapharm			
Pflanzliche Naturprodukte GmbH	B1.0 B15		
Green Light e.K.	B1.0 B16		
Deligreece GmbH	B1.0 B17		
Amodeo Food GmbH	B1.0 B20		
Gmeiner Confiserie & Kaffeehausunternehmen	B1.0 C01		
Brainstream GmbH	B1.0 C02		
Daja Chocolate			
Schokoladenmanufaktur KG	B1.0 C04		
Müller & Lapurina GbR	B1.0 C05		
Pödör Premium Öle und Essige	B1.0 C06		
IMV Spezialitäten-Import, Marketing & Vertriebs GmbH	B1.0 C07		
Villa Masecri GmbH	B1.0 C08		
my-own-coffee Kaffeemanufaktur			
Ingrid Grau	B1.0 C09		
Heise Original Bunzlauer	B1.0 C10		
Kannegießer Keramik	B1.0 C10		
Saxonia Feinsteinzeug-Manufaktur OHG	B1.0 C10		
Patrizia GmbH	B1.0 C20		
Gourmet Berner GmbH & Co. KG	B1.0 C22		
Ahland Handelsagentur oHG	B1.0 C24		
Tassenmann GmbH	B1.0 D01		
Merkle & Biskup OHG	B1.0 D02		
form & linie	B1.0 D03		
H&B Handelskontor GmbH	B1.0 D05		
Teehandel Wordtmann GmbH	B1.0 D06		
Veronica Danneberg	B1.0 D07		
greenomic	B1.0 D08		
Hof Löbke GmbH & Co. KG	B1.0 D18		
Kramer's Spezialitäten GmbH	B1.0 D21		

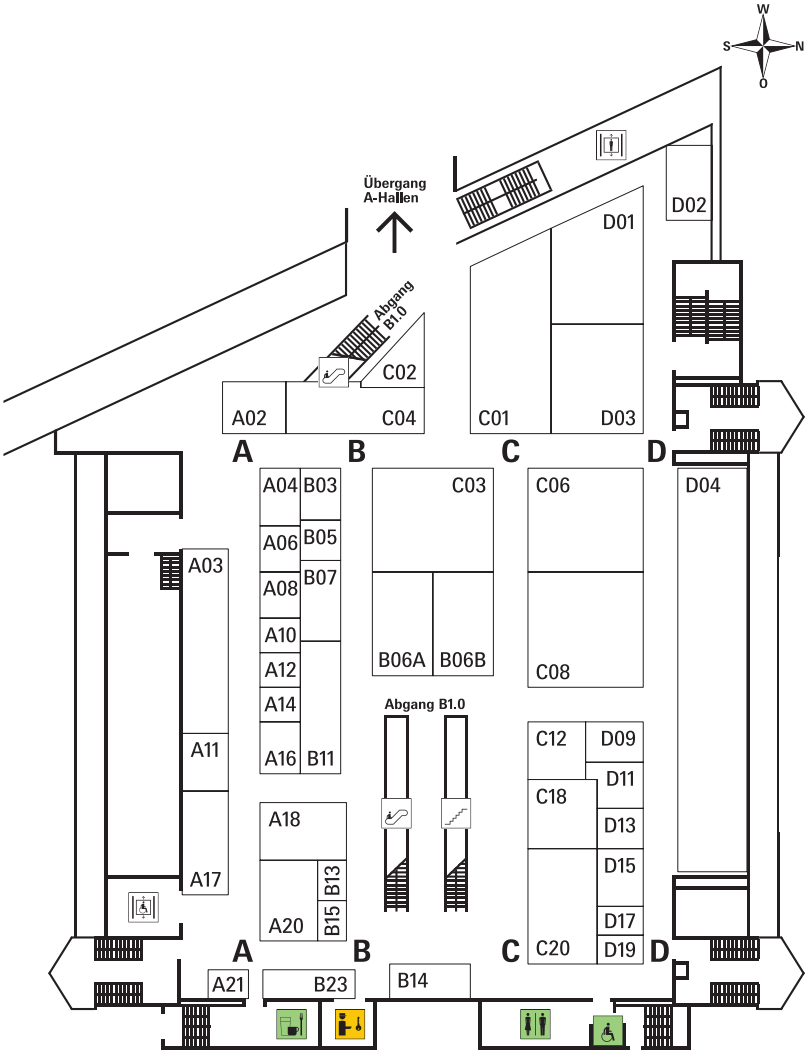

Stand 5. 12. 2017

alphabetisch

Altenburger Senf & Feinkost GmbH & Co. KG	B1.1 B05
APS glass & bar supply GmbH	B1.1 A11
Böker Messer-Manufaktur Solingen	B1.1 D02
Bredemeijer Group B.V.	B1.1 B03
Buah GmbH	B1.1 A14
Handelsvertretung CDH Rolf Bunte	B1.1 B23
Collectors Corner	B1.1 C08
Inh. Susanne Maak e.K.	B1.1 C12
Creano GmbH	B1.1 A02
Creative Tops Limited	B1.1 C08
DreiMeister Spezialitäten	
Hans Schröder GmbH & Co. KG	B1.1 C02
English Tea Shop Germany	B1.1 D15
Essig, Öl & Co. Franchise GmbH	B1.1 C03
Freude am Genuss UG / Gewürzglück	B1.1 A16
HelloFresh Deutschland SE & Co. KG	B1.1 D19
Ad.Hibben GmbH	B1.1 B14
honeyfaktor Paul Büki	B1.1 B15
I love Gifts - Yasmin Abdul Hack	B1.1 A12
Isabelle Rose Home	B1.1 C18
Jameson & Tailor Tee- und Kaffee- zubehör Deutschland GmbH & Co. KG	B1.1 C04
Lifetime Brands Europe Ltd - KITCHEN CRAFT	B1.1 C08
Kremers GmbH	B1.1 A06
Ladelle GmbH	B1.1 A02
Le Creuset GmbH	B1.1 A17
LENCHEN – Der Lebkuchen (Annie Treats GmbH)	B1.1 A10
MAGU GmbH	B1.1 B06B
Mila GmbH	B1.1 B11
M.N.K GmbH	B1.1 A08
Müller Handelsagentur CDH	B1.1 D03
Paul Nagel GmbH & Co. KG	B1.1 B06A
Oleio GmbH	B1.1 D13
Maren Perleberg	B1.1 D09
PSP Deutschland GmbH	B1.1 A18
Rayware Ltd.	B1.1 C12
SCANPAN A/S	B1.1 B07
Brigitte Schaut	B1.1 A21
Sel la vie – Moritz Lübbers	B1.1 B13
Porzellanfabriken Christian Seltmann GmbH	B1.1 D01
Spohn Stefan Handelsvertretung	B1.1 D04
Städter GmbH	B1.1 A03
TEE-MAASS Theodor Maass GmbH	B1.1 C01
think sweet, Inh.: Stefan Wadehn	B1.1 D17
Töpferhof Gramann in Römheld GmbH	B1.1 A04
VICTORINOX AG	B1.1 C20
Wajos GmbH	B1.1 C06
Wally and Whiz ApS	B1.1 D11
Wegter Konsumenten B.V.	B1.1 A20

nach Standnummer

Creano GmbH	B1.1 A02
Ladelle GmbH	B1.1 A02
Städter GmbH	B1.1 A03
Töpferhof Gramann in Römheld GmbH	B1.1 A04
Kremers GmbH	B1.1 A06
M.N.K GmbH	B1.1 A08
LENCHEN – Der Lebkuchen (Annie Treats GmbH)	B1.1 A10
APS glass & bar supply GmbH	B1.1 A11
I love Gifts - Yasmin Abdul Hack	B1.1 A12
Buah GmbH	B1.1 A14
Freude am Genuss UG / Gewürzglück	B1.1 A16
Le Creuset GmbH	B1.1 A17
PSP Deutschland GmbH	B1.1 A18
Wegter Konsumenten B.V.	B1.1 A20
Brigitte Schaut	B1.1 A21
Bredemeijer Group B.V.	B1.1 B03
Altenburger Senf & Feinkost GmbH & Co. KG	B1.1 B05
Paul Nagel GmbH & Co. KG	B1.1 B06A
MAGU GmbH	B1.1 B06B
SCANPAN A/S	B1.1 B07
Mila GmbH	B1.1 B11
Sel la vie – Moritz Lübbers	B1.1 B13
Ad.Hibben GmbH	B1.1 B14
honeyfaktor Paul Büki	B1.1 B15
Handelsvertretung CDH Rolf Bunte	B1.1 B23
TEE-MAASS Theodor Maass GmbH	B1.1 C01
DreiMeister Spezialitäten	
Hans Schröder GmbH & Co. KG	B1.1 C02
Essig, Öl & Co. Franchise GmbH	B1.1 C03
Jameson & Tailor Tee- und Kaffee- zubehör Deutschland GmbH & Co. KG	B1.1 C04
Wajos GmbH	B1.1 C06
Collectors Corner	
Inh. Susanne Maak e.K.	B1.1 C08
Creative Tops Limited	B1.1 C08
Lifetime Brands Europe Ltd - KITCHEN CRAFT	B1.1 C08
Rayware Ltd.	B1.1 C12
Isabelle Rose Home	B1.1 C18
VICTORINOX AG	B1.1 C20
Porzellanfabriken Christian Seltmann GmbH	B1.1 D01
Böker Messer-Manufaktur Solingen	B1.1 D02
Müller Handelsagentur CDH	B1.1 D03
Spohn Stefan Handelsvertretung	B1.1 D04
Maren Perleberg	B1.1 D09
Wally and Whiz ApS	B1.1 D11
Oleio GmbH	B1.1 D13
English Tea Shop Germany	B1.1 D15
think sweet, Inh.: Stefan Wadehn	B1.1 D17
HelloFresh Deutschland SE & Co. KG	B1.1 D19

Halle B2 Hall B2

Schmuck & Mode, Entspannung & Pflege
Jewellery & Fashion, Relaxation & Well-Being

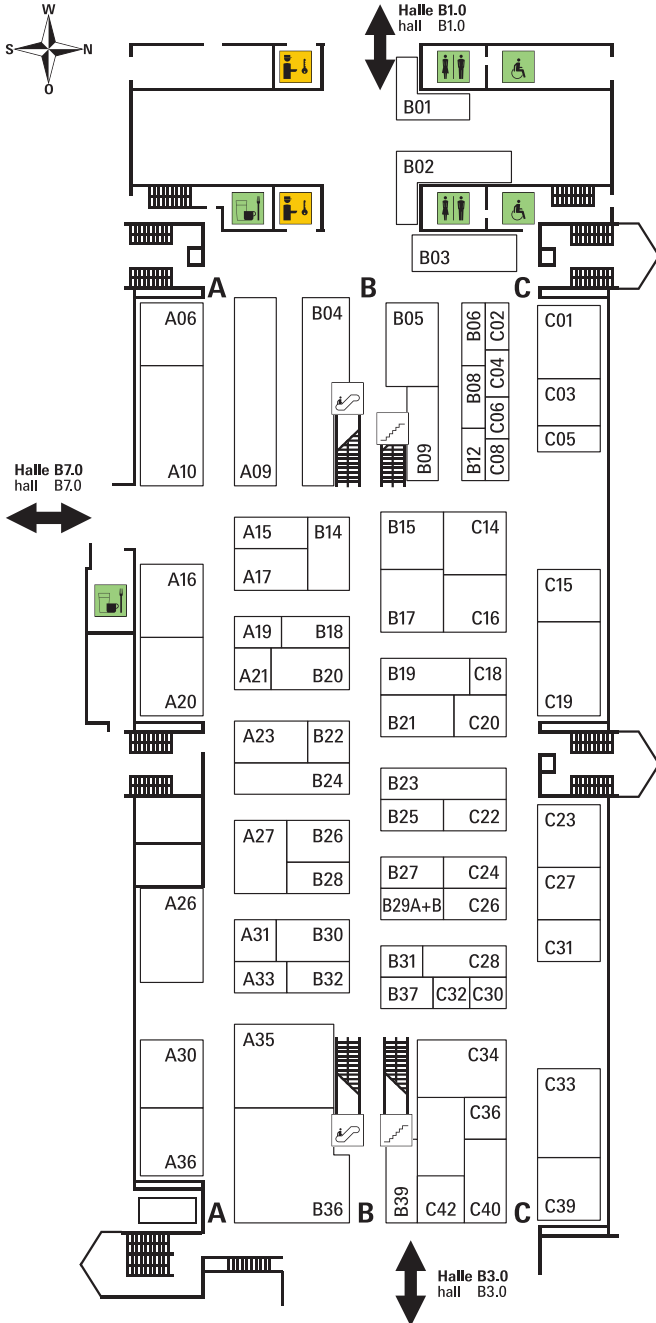

Stand 5. 12. 2017

alphabetisch

Accentra GmbH & Co. KG	B2.0 B04	Merlin Lederwarenvertrieb & Services GmbH	B2.0 C16
APC-NCC Lederwaren GmbH	B2.0 A35	MOOSMED Natural Cosmetics GmbH	B2.0 B14
Konrad Arnold GmbH & Co. KG	B2.0 B20	Nappa Lux Lederwaren GmbH	B2.0 A33
Hans Baier e.K. Inh. Alina Baier	B2.0 B22	Naturfreunde MV GmbH	B2.0 B06
Barracuda Stylecompany, Ronny Weinert	B2.0 B36	Neuhaus Lederwaren Thorsten Neuhaus	B2.0 A17
BECKER-MANICURE SOLINGEN Siegfried Becker e.K.	B2.0 B15	Müller & Schmidt Pfeilringwerk GmbH & Co. KG	B2.0 C24
BECO Beermann GmbH & Co. KG	B2.0 A20	Primetta GmbH & Co. KG	B2.0 C18
Bellissima Creation GmbH	B2.0 C40	Pure Schönheit - Renée Dittrich	B2.0 C04
Berufsgenossenschaft Handel und Warenlogistik (BGHW)	B2.0 C01	Rainbow Im- & Export GmbH	B2.0 B09
BO Cosmetic GmbH	B2.0 A09	RIC DENMARK ApS	B2.0 A23
Werkstatt hinten-oben Inh. Beatrix Böhme	B2.0 B29B	Saebevaerkstedet v/Lone Sarto Pedersen	B2.0 A23
Get fresh Cosmetics Ltd. t/a BOMB COSMETICS	B2.0 A06	Sanddollar GmbH & Co. KG	B2.0 C08
Bulaggi & More BV	B2.0 C15	scapo - Andrea König	B2.0 C30
Brigitte Butt	B2.0 C26	Scented Cubes - Wolfgang Kanzler	B2.0 B32
Jerome Canlorbe SAS - Bombata	B2.0 C36	Scheers schöne Dinge	B2.0 B25
Casada Deutschland GmbH	B2.0 C03	Schröder Packfix GmbH	B2.0 B20
Cita Lieta SIA	B2.0 A31	seaSTARbag GbR	B2.0 C32
Leder Waldherr CLM / Cinino / Bayern Bag	B2.0 B30	SHOE AND MORE Gerhard Oswald	B2.0 C06
Werner Czarnecki	B2.0 B24	Somerset Toiletry Co., Ltd.	B2.0 B26
Dernier GmbH	B2.0 C34	Spa Vivent Vertriebs GmbH	B2.0 B37
Ebarrito SRL	B2.0 A26	Spiderkites Gutgesell/Fokken GbR	B2.0 C02
FASHY GmbH Produktion und Vertrieb	B2.0 C39	STREET LEVEL BAGS - TRIPLE 7 EUROPE BV	B2.0 C19
Fausto GmbH & Co. KG	B2.0 B17	Erwin Thesing Handelsvertreter CDH	B2.0 B02
Frosch & Rabe	B2.0 B12	Top Team Collection GmbH	B2.0 A16
Gosch Shoes GbR	B2.0 B27	Traumduft GmbH	B2.0 B39
heller vertrieb	B2.0 B18	Village Cosmetics GmbH & Co. KG	B2.0 B28
HEMSLEY LIVING Jens Köster	B2.0 B01	VOI Leather Design GmbH & Co. KG	B2.0 A10
HL Lederwaren B.V.	B2.0 A27	WR-Accessoires GmbH	B2.0 A21
India Basar, Fa. Steffi Sharma	B2.0 C22		
Indian Lotus Pvt. Ltd.	B2.0 C20		
Inntaler Naturprodukte GmbH	B2.0 C23		
Richard Jäger Inh. Doris Becker	B2.0 A15		
Jalan-Jalan GmbH	B2.0 C27		
Janne K. Kolding ApS	B2.0 B19		
Kerzenfarm Hahn e. K.	B2.0 B21		
Kerzenfarm Hahn e. K.	B2.0 B23		
Kett Kiss	B2.0 B29A		
Klar Seifen GmbH	B2.0 A19		
Konert Home GmbH	B2.0 B05		
La Jolie Maison	B2.0 C28		
Landleder GmbH	B2.0 A35		
Larsson Interior	B2.0 A23		
Jean Lasschuit Products B.V.	B2.0 B08		
L.CREDI Peugler GmbH	B2.0 C42		
LEIKOR Direktimporte			
Petra Leiers-Kording	B2.0 B03		
Like it a lot	B2.0 A36		
Ines Behrens-Kunkel GmbH / LillyKunkelDesign	B2.0 C05		
Der Lindwurm HGmbH	B2.0 C31		
MALIQUE	B2.0 A30		
Marco Venezia			
c.o Heinen Warenhandels GmbH	B2.0 C14		
MEDIALMED - Spittler	B2.0 B31		
Wilhelm Johann Meier GmbH	B2.0 C33		

Halle B2
Hall B2

Schmuck & Modee, Entspannung & Pflege
Jewellery & Fashion, Relaxation & Well-Being

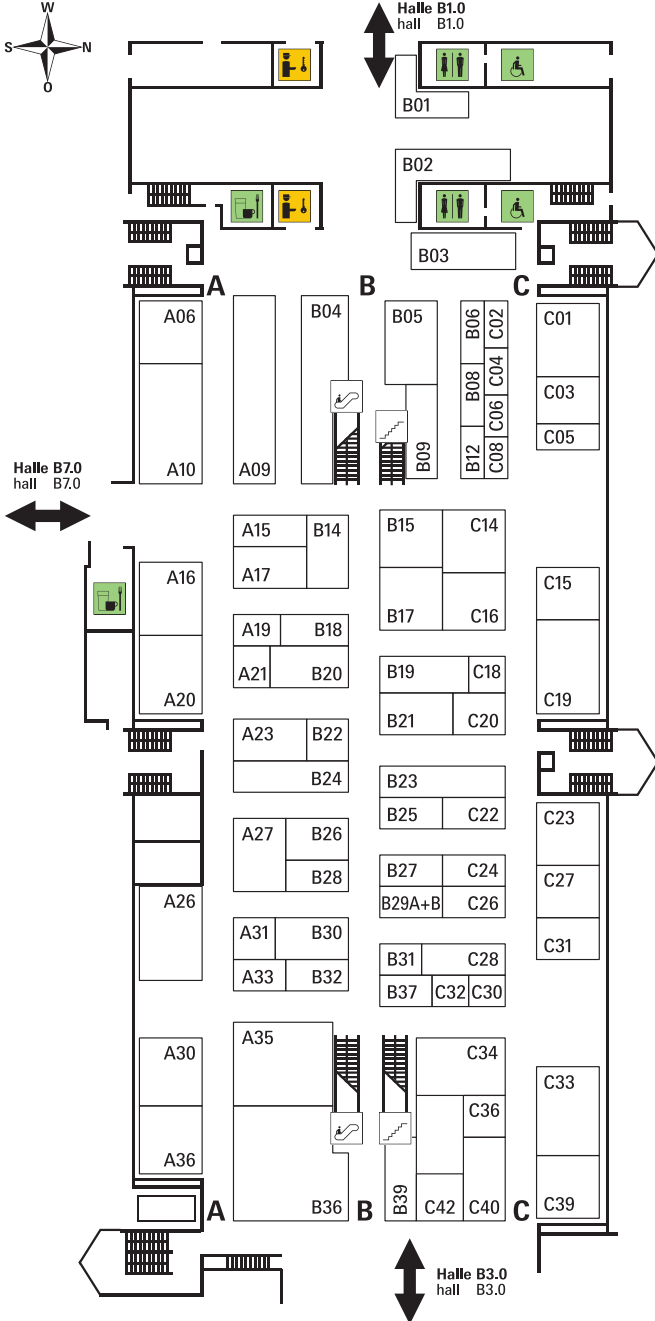

Stand 5. 12. 2017

nach Standnummer

Get fresh Cosmetics Ltd. t/a BOMB COSMETICS	B2.0 A06	Spiderkites Gutgesell/Fokken GbR	B2.0 C02
BO Cosmetic GmbH	B2.0 A09	Casada Deutschland GmbH	B2.0 C03
VOI Leather Design GmbH & Co. KG	B2.0 A10	Pure Schönheit - Renée Dittrich	B2.0 C04
Richard Jäger Inh. Doris Becker	B2.0 A15	Ines Behrens-Kunkel GmbH / LillyKunkelDesign	B2.0 C05
Top Team Collection GmbH	B2.0 A16	SHOE AND MORE Gerhard Oswald	B2.0 C06
Neuhaus Lederwaren Thorsten Neuhaus	B2.0 A17	Sanddollar GmbH & Co. KG	B2.0 C08
Klar Seifen GmbH	B2.0 A19	Marco Venezia c.o Heinen Warenhandels GmbH	B2.0 C14
BECO Beermann GmbH & Co. KG	B2.0 A20	Bulaggi & More BV	B2.0 C15
WR-Accessoires GmbH	B2.0 A21	Merlin Lederwarenvertrieb & Services GmbH	B2.0 C16
Larsson Interior	B2.0 A23	Primetta GmbH & Co. KG	B2.0 C18
RIC DENMARK ApS	B2.0 A23	STREET LEVEL BAGS - TRIPLE 7 EUROPE BV	B2.0 C19
Saebevaerkstedet v/Lone Sarto Pedersen	B2.0 A23	Indian Lotus Pvt. Ltd.	B2.0 C20
Ebarrito SRL	B2.0 A26	India Basar, Fa. Steffi Sharma	B2.0 C22
HL Lederwaren B.V.	B2.0 A27	Inntaler Naturprodukte GmbH	B2.0 C23
MALIQUE	B2.0 A30	Müller & Schmidt Pfeilringwerk GmbH & Co. KG	B2.0 C24
Cita Lieta SIA	B2.0 A31	Brigitte Butt	B2.0 C26
Nappa Lux Lederwaren GmbH	B2.0 A33	Jalan-Jalan GmbH	B2.0 C27
APC-NCC Lederwaren GmbH	B2.0 A35	La Jolie Maison	B2.0 C28
Landleder GmbH	B2.0 A35	scapo – Andrea König	B2.0 C30
Like it a lot	B2.0 A36	Der Lindwurm HGmbH	B2.0 C31
HEMSLEY LIVING Jens Köster	B2.0 B01	seaSTARbag GbR	B2.0 C32
Erwin Thesing Handelsvertreter CDH	B2.0 B02	Wilhelm Johann Meier GmbH	B2.0 C33
LEIKOR Direktimporte Petra Leiers-Kording	B2.0 B03	Demier GmbH	B2.0 C34
Accentra GmbH & Co. KG	B2.0 B04	Jerome Canlorbe SAS - Bombata	B2.0 C36
Konert Home GmbH	B2.0 B05	FASHY GmbH Produktion und Vertrieb	B2.0 C39
Naturfreunde MV GmbH	B2.0 B06	Bellissima Creation GmbH	B2.0 C40
Jean Lasschuit Products B.V.	B2.0 B08	L.CREDI Peugler GmbH	B2.0 C42
Rainbow Im- & Export GmbH	B2.0 B09		
Frosch & Rabe	B2.0 B12		
MOOSMED Natural Cosmetics GmbH	B2.0 B14		
BECKER-MANICURE SOLINGEN Siegfried Becker e.K.	B2.0 B15		
Fausto GmbH & Co. KG	B2.0 B17		
heller vertrieb	B2.0 B18		
Janne K. Kolding ApS	B2.0 B19		
Konrad Arnold GmbH & Co. KG	B2.0 B20		
Schröder Packfix GmbH	B2.0 B20		
Kerzenfarm Hahn e. K.	B2.0 B21		
Hans Baier e.K. Inh. Alina Baier	B2.0 B22		
Kerzenfarm Hahn e. K.	B2.0 B23		
Werner Czarnecki	B2.0 B24		
Scheers schöne Dinge	B2.0 B25		
Somerset Toiletry Co., Ltd.	B2.0 B26		
Gosch Shoes GbR	B2.0 B27		
Village Cosmetics GmbH & Co. KG	B2.0 B28		
Kett Kiss	B2.0 B29A		
Werkstatt hinten-oben Inh. Beatrix Böhme	B2.0 B29B		
Leder Waldherr CLM / Cinino / Bayern Bag	B2.0 B30		
MEDIALMED – Spittler	B2.0 B31		
Scented Cubes - Wolfgang Kanzler	B2.0 B32		
Barracuda Stylecompany, Ronny Weinert	B2.0 B36		
Spa Vivent Vertriebs GmbH	B2.0 B37		
Traumduft GmbH	B2.0 B39		
Berufsgenossenschaft Handel und Warenlogistik (BGHW)	B2.0 C01		

Halle B3
Hall B3

Haus & Garten
Home & Garden

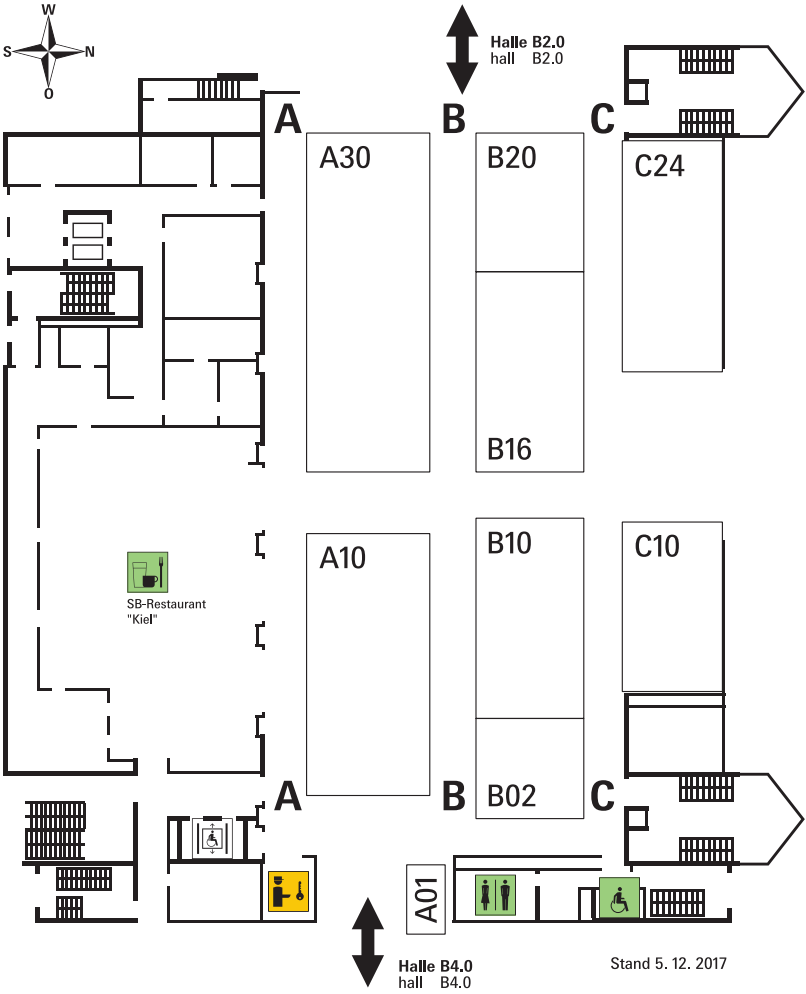

alphabetisch

Basic Decorations	B3.0 B02
Bell' Arte Thomas Gröner Einzelirma	B3.0 B20
Eja International ApS	B3.0 B10
Eja International ApS	B3.0 C10
Figurendiscounter GmbH & Co. KG	B3.0 C24
Xmas-Art Hartmann Handels GmbH	B3.0 A01
Friedrich Klocke GmbH & Co. KG	B3.0 B16
Mrowka, Thomas Handelsagentur	B3.0 B20
San Marco GmbH	B3.0 A10
San Marco GmbH	B3.0 A30

nach Standnummer

Xmas-Art Hartmann Handels GmbH	B3.0 A01
San Marco GmbH	B3.0 A10
San Marco GmbH	B3.0 A30
Basic Decorations	B3.0 B02
Eja International ApS	B3.0 B10
Friedrich Klocke GmbH & Co. KG	B3.0 B16
Bell' Arte Thomas Gröner Einzelirma	B3.0 B20
Mrowka, Thomas Handelsagentur	B3.0 B20
Eja International ApS	B3.0 C10
Figurendiscounter GmbH & Co. KG	B3.0 C24

Halle B4 Hall B4

Haus & Garten
Home & Garden

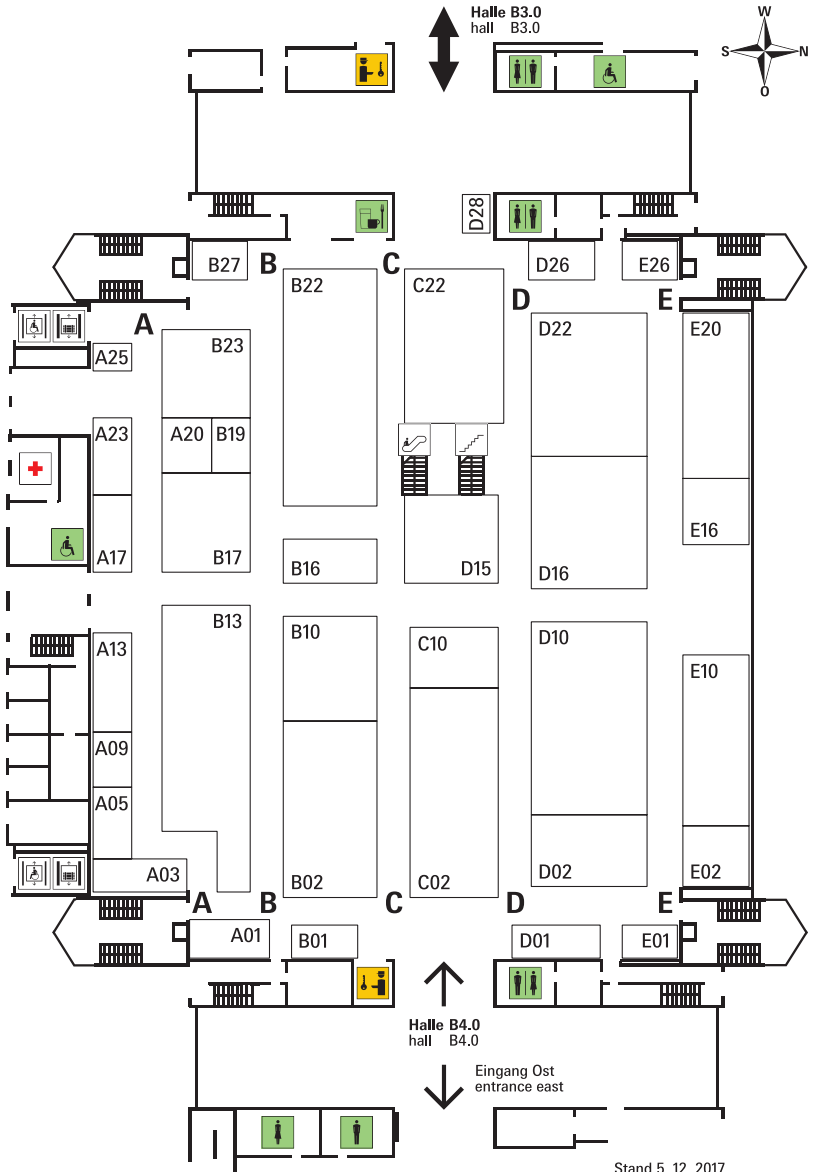

alphabetisch

Badeko GmbH	B4.0 B22
Beauty Group, Frank Schmidt Import	B4.0 C22
Glasbläserei Christian Bernschein	B4.0 B27
Bettin	
Handelsgesellschaft mbH & Co. KG	B4.0 D10
CLASSICO Modern Living	B4.0 B17
Colours & Green B.V.	B4.0 E20
Colours in Motion GmbH	B4.0 E16
Decostar	B4.0 C02
EMKA - Papier und Folienverarbeitungs GmbH	B4.0 A13
FW-Glas GmbH Frankenwaldglas	B4.0 D01
Glatzel & Glatzel	B4.0 A17
Goldbach Geschenkartikel GmbH	B4.0 B13
Handelsverband Nord e.V.	B4.0 D28
Herrnhuter Sterne GmbH	B4.0 A20
das Holzschild	B4.0 A03
Ideenwerkstatt, B.G.F.GmbH	B4.0 B01
Jambavan Inh.: Monika Bäres	B4.0 A23
Jodeco Glass B.V.	B4.0 B10
Jodeco Glass B.V.	B4.0 B16
Krenz GmbH	B4.0 D15
Krenz GmbH	B4.0 D16
Kathrin Kynast e.K. Import - Export	B4.0 D02
Peter Lüders - Creativ Concept	B4.0 D26
Ludwig-Lutex Gobelin Manufacture	B4.0 E02
Helmut Martin e.K.	B4.0 B23
Otto-Keramik Inh. Otto Gerharz	B4.0 E01
Phoenix TT GmbH & Co. KG	B4.0 C10
Pusteblume GmbH	B4.0 A01
Pusteblume GmbH	B4.0 B02
Georg Schäfer GmbH & Co. Handels KG	B4.0 A09
Schmidt GmbH Floristik & Dekorationsgroßhandel	B4.0 D22
SKULPI Ebeling GmbH	B4.0 A25
Spang GmbH	B4.0 E10
Spieluhrenwelt - MMM GmbH	B4.0 A05
Zimba-Arts	B4.0 B19

nach Standnummer

Pusteblume GmbH	B4.0 A01
das Holzschild	B4.0 A03
Spieluhrenwelt - MMM GmbH	B4.0 A05
Georg Schäfer GmbH & Co. Handels KG	B4.0 A09
EMKA - Papier und Folienverarbeitungs GmbH	B4.0 A13
Glatzel & Glatzel	B4.0 A17
Herrnhuter Sterne GmbH	B4.0 A20
Jambavan Inh.: Monika Bäres	B4.0 A23
SKULPI Ebeling GmbH	B4.0 A25
Ideenwerkstatt, B.G.F.GmbH	B4.0 B01
Pusteblume GmbH	B4.0 B02
Jodeco Glass B.V.	B4.0 B10
Goldbach Geschenkartikel GmbH	B4.0 B13
Jodeco Glass B.V.	B4.0 B16
CLASSICO Modern Living	B4.0 B17
Zimba-Arts	B4.0 B19
Badeko GmbH	B4.0 B22
Helmut Martin e.K.	B4.0 B23
Glasbläserei Christian Bernschein	B4.0 B27
Decostar	B4.0 C02
Phoenix TT GmbH & Co. KG	B4.0 C10
Beauty Group, Frank Schmidt Import	B4.0 C22
FW-Glas GmbH Frankenwaldglas	B4.0 D01
Kathrin Kynast e.K. Import - Export	B4.0 D02
Bettin	
Handelsgesellschaft mbH & Co. KG	B4.0 D10
Krenz GmbH	B4.0 D15
Krenz GmbH	B4.0 D16
Schmidt GmbH Floristik & Dekorationsgroßhandel	B4.0 D22
Peter Lüders - Creativ Concept	B4.0 D26
Handelsverband Nord e.V.	B4.0 D28
Otto-Keramik Inh. Otto Gerharz	B4.0 E01
Ludwig-Lutex Gobelin Manufacture	B4.0 E02
Spang GmbH	B4.0 E10
Colours in Motion GmbH	B4.0 E16
Colours & Green B.V.	B4.0 E20
Schmidt GmbH Floristik & Dekorationsgroßhandel	B4.0 E26

Halle B5 Hall B5

Haus & Garten, Souvenirs
Home & Garden, Souvenirs

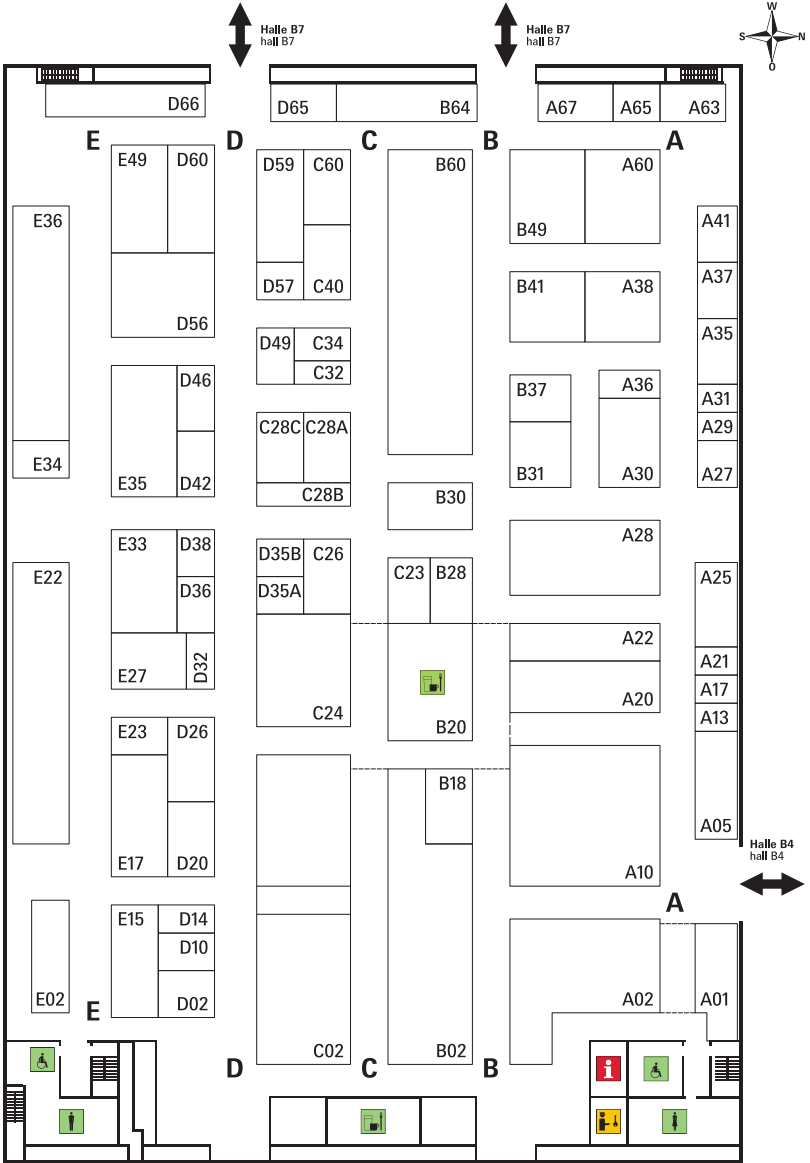

Stand 5. 12. 2017

alphabetisch

andrea design GmbH & Co. KG	B5.0 A20
ARTenreich GLAS	
Kunstwerkstatt Artenreich	B5.0 A37
ARTHO CREATION – Malerei Kunst	B5.0 A27
AWT Trading GmbH	B5.0 D65
Balcikonis & Balcikoniene GbR	B5.0 A29
Bambus Dreams GmbH - TRAMARK	B5.0 C34
Chr. Bollweg e.K.	B5.0 B02
Bukowski Design, Kunst und Keramik, TazTrade-Handelsagentur J. Dembowa	B5.0 E02
Casa Bonita Art of Glass	B5.0 D38
CASSIA – the decoration company Lars Spreckelmeyer e.K.	B5.0 A22
Chic Antique v/Bente Kienast	B5.0 A28
Cornelissen	
naTierliche Geschenke GmbH & Co. KG	B5.0 E15
COROC UG (haftungsbeschränkt)	B5.0 D49
Cottage Garden Inh. Helga Däumler	B5.0 A67
Création Groß	B5.0 E27
Dreamlights	B5.0 A21
Dressler & Zimmerhagl KG	B5.0 E17
Enesco Limited	B5.0 A25
Exner GmbH	B5.0 C02
Ferrum Art Design GmbH & Co. KG	B5.0 B49
Five Oaks Int. Europe Ltd.	B5.0 C28B
FLORA FEE,	
Rolf Lienenbecker GmbH & Co. KG	B5.0 D26
Fragrance & Style GmbH	B5.0 B28
Handelsagentur Anne Garber Inh. Lutz Garber	B5.0 D56
Geschenkartikel aus aller Welt Inh. Thomas Nürnberger	B5.0 D36
Goldline GmbH	B5.0 D56
HanseFlag GmbH	B5.0 D60
Harmsen Trading GmbH	B5.0 A65
hausgemachtwohnen GbR	B5.0 A13
Reinhold W. Heim GmbH & Co. KG	B5.0 E17
Josef Hoffmann Porzellan- und Glasveredelung Inh. Heike Hoffmann	B5.0 E17
Vertriebsagentur SH Stefan Holzmann	B5.0 E17
Home Society B.V.	B5.0 C24
HUBLOT MODE MARINE / ARTESANIA ESTEBAN FERRER S.L.	B5.0 D57
Inis the Energy of the Sea	B5.0 D42
Julia & Juliette BV	B5.0 A63
Karena International Sprl	B5.0 A35
Knote Handelsagentur / Artesania Esteban Ferrer S.L.	B5.0 D59
Friedrich Carl Kopp	B5.0 E17
KRÜGER MARITIM GmbH	B5.0 C40
LAVINIA-collection Germany GmbH & Co. KG	B5.0 A30
Madleys	B5.0 B31
Maj Isenkram ApS	B5.0 D20
Maritim World GbR	B5.0 D10
MELLI MELLO	B5.0 B37
MGM Meyer's göttliches Meublement Stefan Meyer	B5.0 C23
Miljogarden HB B O U Wihlborg	B5.0 B60
Millefiori S.r.l	B5.0 B41
Montag GmbH	B5.0 E17
Müsing GmbH & Co. KG	B5.0 A38

Nautic Hamburg	
Maritime Handels GmbH & Co. KG	B5.0 C60
Pape Kunstgewerbe GmbH & Co. KG	B5.0 A05
Passerelle Design BVBA	B5.0 C32
PD Geschenke Inh. Jianrong Tu	B5.0 E23
Pfronten-Schmuck GmbH	B5.0 D66
Horst Platow - Muscheln und Geschenkartikel Import und Export	B5.0 E33
Posiwio GmbH & Co. Vertriebs KG	B5.0 A10
Power Gift s.c., Maciej Blaszczyk Ireneusz Sadowski	B5.0 E34
PPS-Schimmel GmbH	B5.0 D46
Christian Prenzler - Steintechnik und Bildhauer	B5.0 A36
Privat Collection	B5.0 B64
RAHLF GmbH	B5.0 E36
Handelsagentur Ralf Richter	B5.0 D02
Rieck & Melzian	
Metalltechnik GmbH & Co. KG	B5.0 A31
SABODesign GmbH	B5.0 B30
SEA-CLUB Handels-GmbH	B5.0 E49
Seyko-Geschenke Inh. Heiko Seyferth	B5.0 B18
SIMA Textil-Vertrieb GmbH	
Fischerhemden und Tücher	B5.0 D14
SL. GESCHENKE, Stephan Lau	B5.0 E35
Soap & Gifts BVBA	B5.0 D35A
Tango Deko und Geschenke Inh.: Winfried Hutzler	B5.0 A60
Tawa Albert Weishaupt AG	B5.0 E17
Tomkow	B5.0 A17
TRENDS Claus Lehmann	B5.0 C26
VIB Very Important Baby	B5.0 D35B
Vidroflor Warenhandels GmbH	B5.0 C28A
Vosteen Import	B5.0 A01
Export GmbH	B5.0 A02
Gerhard Wagner Großhandels GmbH	B5.0 D32
WAT – World Art Trade Klaus Bühler	B5.0 A41
Frank Wilhahn e.K.	B5.0 E22
Yankee Candle Deutschland GmbH	B5.0 B41
Zauberblume GmbH	B5.0 C28C

Halle B5 Hall B5

Haus & Gartenn, Souvenirs
Home & Garden, Souvenirs

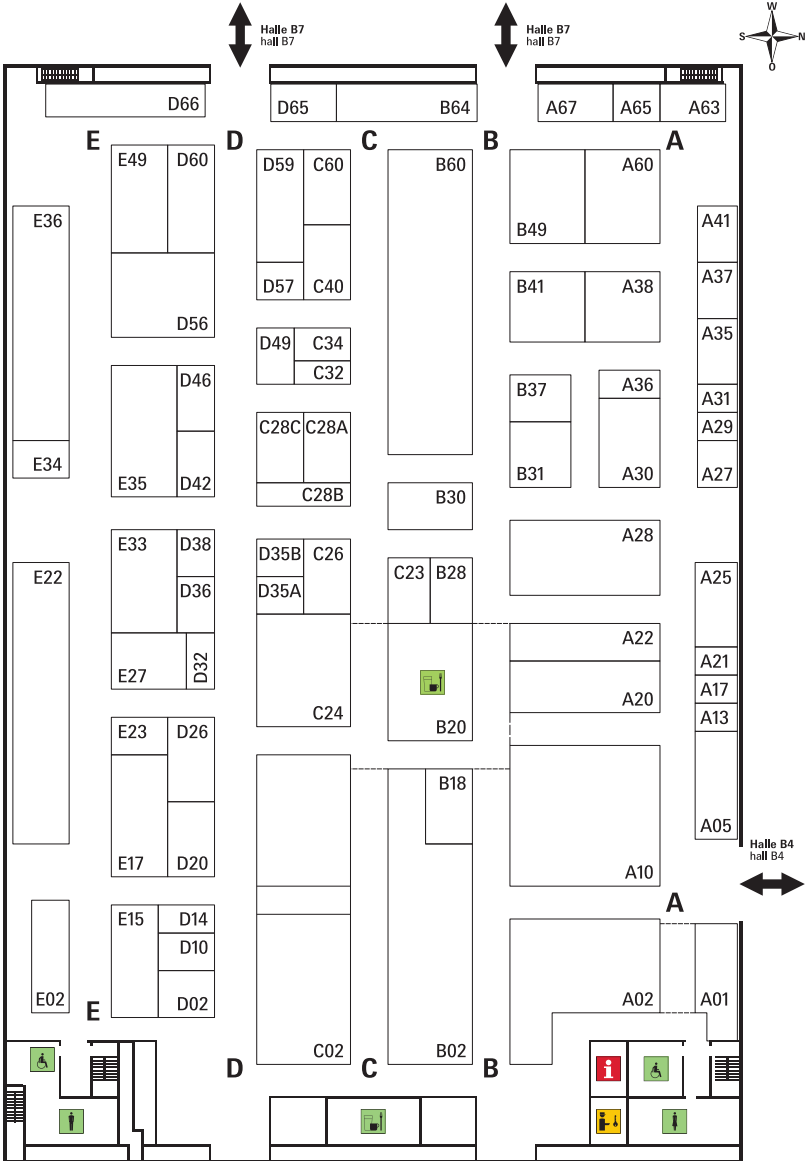

Stand 5. 12. 2017

nach Standnummer

	Soap & Gifts BVBA	B5.0 D35A
Vosteen	VIB Very Important Baby	B5.0 D35B
Import Export GmbH	Geschenkartikel aus aller Welt	
Pape Kunstgewerbe GmbH & Co. KG	Inh. Thomas Nürnberger	B5.0 D36
Posiwio GmbH & Co. Vertriebs KG	Casa Bonita Art of Glass	B5.0 D38
hausgemachtwohnen GbR	Inis the Energy of the Sea	B5.0 D42
Tomkow	PPS-Schimmel GmbH	B5.0 D46
andrea design GmbH & Co. KG	COROC UG (haftungsbeschränkt)	B5.0 D49
Dreamlights	Handelsagentur Anne Garber	
CASSIA – the decoration company	Inh. Lutz Garber	B5.0 D56
Lars Spreckelmeyer e.K.	Goldline GmbH	B5.0 D56
Enesco Limited	HUBLLOT MODE MARINE /	
ARTHOCREATION – Malerei Kunst	ARTESANIA ESTEBAN FERRER S.L.	B5.0 D57
Chic Antique v/Bente Kienast	Knote Handelsagentur /	
Balcikonis & Balcikoniene GbR	Artesania Esteban Ferrer S.L.	B5.0 D59
LAVINIA-collection	HanseFlag GmbH	B5.0 D60
Germany GmbH & Co. KG	AWT Trading GmbH	B5.0 D65
Rieck & Melzian	Pffronten-Schmuck GmbH	B5.0 D66
Metalltechnik GmbH & Co. KG	Bukowski Design, Kunst und Keramik,	
Karena International Sprl	TazTrade-Handelsagentur J. Dembowa	B5.0 E02
Christian Prenzler -	Cornelissen	
Steintechniker und Bildhauer	naTierliche Geschenke GmbH & Co. KG	B5.0 E15
ARTenreich GLAS	Dressler & Zimmerhagl KG	B5.0 E17
Kunstwerkstatt Artenreich	Reinhold W. Heim GmbH & Co. KG	B5.0 E17
Müsing GmbH & Co. KG	Josef Hoffmann Porzellan-	
WAT – World Art Trade Klaus Bühler	und Glasveredelung	
Tangoo Deko und Geschenke	Inh. Heike Hoffmann	B5.0 E17
Inh.: Winfried Hutzler	Vertriebsagentur SH Stefan Holzmann	B5.0 E17
Julia & Juliette BV	Friedrich Carl Kopp	B5.0 E17
Harmsen Trading GmbH	Montag GmbH	B5.0 E17
Cottage Garden Inh. Helga Däumler	Tawa Albert Weishaupt AG	B5.0 E17
Chr. Bollweg e.K.	Frank Wilhahn e.K.	B5.0 E22
Seyko-Geschenke Inh. Heiko Seyferth	PD Geschenke Inh. Jianrong Tu	B5.0 E23
Fragrance & Style GmbH	Création Groß	B5.0 E27
SABODesign GmbH	Horst Platow - Muscheln und	
Madleys	Geschenkartikel Import und Export	B5.0 E33
MELLI MELLO	Power Gift s.c.,	
Millefiori S.r.l	Maciej Blaszczyk Ireneusz Sadowski	B5.0 E34
Yankee Candle Deutschland GmbH	SL. GESCHENKE, Stephan Lau	B5.0 E35
Ferrum Art Design GmbH & Co. KG	RAHLF GmbH	B5.0 E36
Miljogarden HB B O U Wihlborg	SEA-CLUB Handels-GmbH	B5.0 E49
Privat Collection		
Exner GmbH		
MGM Meyer's göttliches Meublement		
Stefan Meyer	B5.0 C23	
Home Society B.V.	B5.0 C24	
TRENDS Claus Lehmann	B5.0 C26	
Vidroflor Warenhandels GmbH	B5.0 C28A	
Five Oaks Int. Europe Ltd.	B5.0 C28B	
Zauberblume GmbH	B5.0 C28C	
Passerelle Design BVBA	B5.0 C32	
Bambus Dreams GmbH - TRAMARK	B5.0 C34	
KRÜGER MARITIM GmbH	B5.0 C40	
Nautic Hamburg		
Maritime Handels GmbH & Co. KG	B5.0 C60	
Handelsagentur Ralf Richter	B5.0 D02	
Maritim World GbR	B5.0 D10	
SIMA Textil-Vertrieb GmbH		
Fischerhemden und Tücher	B5.0 D14	
Maj Isenkram ApS	B5.0 D20	
FLORA FEE,		
Rolf Lienenbecker GmbH & Co. KG	B5.0 D26	
Gerhard Wagner Großhandels GmbH	B5.0 D32	

Halle B7 Hall B7

Schmuck & Mode
Jewellery & Fashion

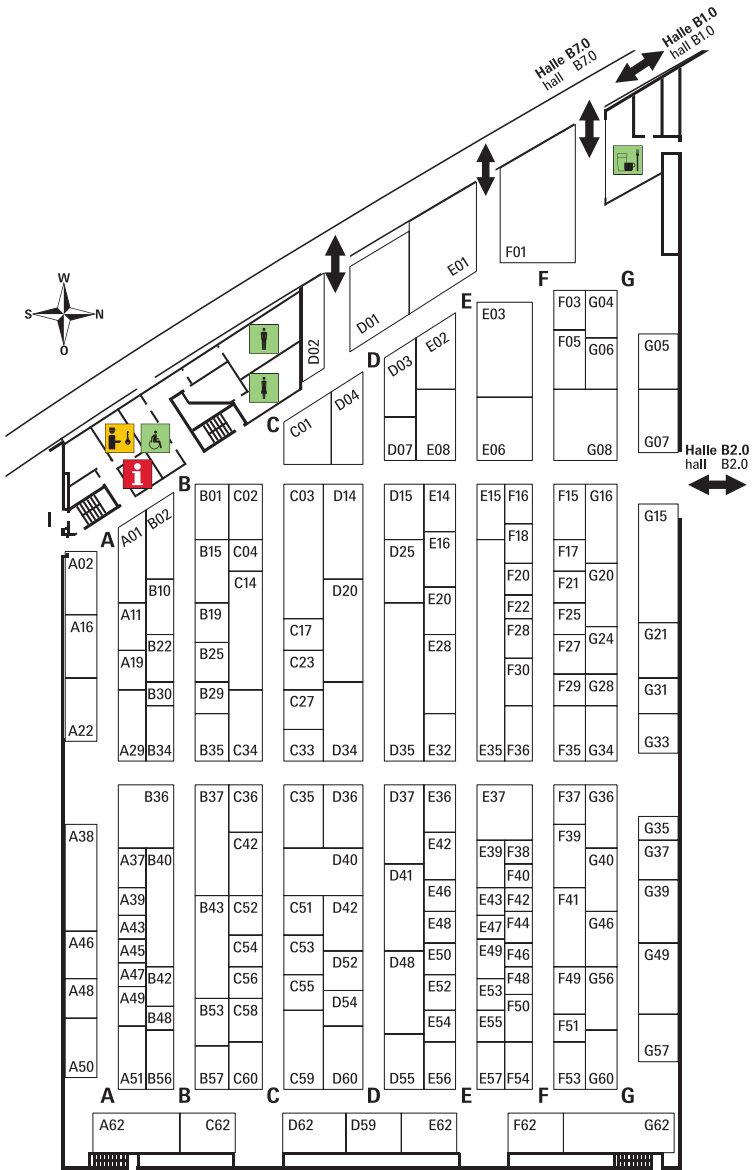

Stand 5. 12. 2017

alphabetisch

Accessoires and More	B7.0 A02	Geo-Expert Michael Vogt	B7.0 G21
ADI-Modenschmuck		Siegfried Giede GmbH	B7.0 G49
Inh. Sabine Schifferer	B7.0 F39	Go Dutch Label B.V.	B7.0 E20
A. Ahmaddy Tücher und Schals	B7.0 A62	GO2 GmbH	B7.0 B10
AHSchmuckdesign e. Kfr.		Goldline GmbH	B7.0 C03
Inh. Heidi Hübner	B7.0 F15	Goldline GmbH	B7.0 G62
AJOLA® GbR	B7.0 F28	Green Factory Colombia GmbH	B7.0 F54
Amberworld Bernsteinmanufaktur		Grethe Winter UG (haftungsbeschränkt)	B7.0 F17
Hamburg Jens von Holt e.K.	B7.0 D15	Max Grubba Galerie Eldorado	B7.0 B29
AMBRA Schmuck-Atelier	B7.0 A19	GSK Gerhard Sagner GmbH & Co. KG	B7.0 E43
Aqua dulce v/Janne Lisberg Fisker	B7.0 B25	Gubo Schmuck Inh. Thomas Gubo	B7.0 F03
Ariana Lapis e.K.	B7.0 E37	HATS Handelsgesellschaft mbH	B7.0 F62
ARNAVA - Schmuck & Edelsteine, Inh. Christian Grünert	B7.0 G46	HEIDEKÖNIGIN Textilhandels GmbH	B7.0 B53
Aslan Bijuteri Taki San. ve Dis Tic. Ltd. Sti	B7.0 F49	Monika Herré	B7.0 F20
Atlantis Accessories GmbH	B7.0 F42	HIGHLIGHT Company Carla Kemper	B7.0 B40
Australian Fashion House GmbH	B7.0 D52	Himalaya Textilhandels GmbH	B7.0 D59
B-Latitude	B7.0 F44	Hizkiahu Kupfer	B7.0 C34
Bachtar Kleinod oHG	B7.0 G24	Sabine Hofius Design GmbH	B7.0 D36
Bahl Collection	B7.0 D01	Hühnerloung, Inh. Tina Schuster	B7.0 B48
Balke Fashion GmbH	B7.0 D41	Hultquist – Copenhagen	B7.0 B34
Barracuda Stylecompany, Ronny Weinert	B7.0 G35	iCrush GmbH	B7.0 F41
Bender-Schmuck Dominik Bender und Hermann Bender GbR Création Amélie Biba B.V.	B7.0 B01	Impala Silberschmuck, Angelika Matuszczak	B7.0 G57
Blue Beads Company	B7.0 F01	Interior Kunst und Einrichtung	
BMS Bernd-Michael Schröder	B7.0 G07	Inhaber Monica Dadder	B7.0 A43
Sailing Wear GmbH	B7.0 C35	Island Wollparadies	B7.0 D48
Bodywings	B7.0 E08	Jalfe ApS	B7.0 F53
BOOM International Trading GmbH	B7.0 C62	Jeh Collection BV	B7.0 E56
Bunte Wolken - Schönes aus Asien Yingwen Chen	B7.0 E46	Tom Joule	B7.0 E50
Campur GmbH	B7.0 E06	J.U.S.T. Trends GmbH	B7.0 A22
CLARO Handels-GmbH	B7.0 E01	JustWin Schmuck Design	B7.0 A29
Colours Cosmetic GmbH	B7.0 B37	KABUKI Country KG	B7.0 C04
Creative Minds Revive B.V.	B7.0 E52	Kashmir Arts	B7.0 A51
Culture Mix B.V.	B7.0 E28	Katahati, Sabine Krummradt	B7.0 C02
De La Haye Schmuck-Import	B7.0 E02	KINTAMANI e.K.	
DEMarie Schmuckvertrieb Doris Haver	B7.0 F30	Inh. Rainer Schickedanz	B7.0 G56
DI Perle GmbH	B7.0 F36	R. Klee Edelsteinhandlung e. K.	B7.0 A38
Diggers Garden	B7.0 C58	Handelsagentur Kleiderprofi Jutta Höbermann	B7.0 C56
Warenhandels GmbH	B7.0 C59	Christoph Koch	B7.0 G36
direkta moden		Gerdis Koch e.K.	B7.0 C33
Handelsgesellschaft mbH	B7.0 A16	A. Krikor GmbH Mode-Schmuck	B7.0 B35
Mark Duckworth	B7.0 G60	KT-Schmuckdesign GmbH & Co.KG	B7.0 B15
DUR Schmuck GmbH	B7.0 E03	Kunsthandwerk und Schmuck Petra Sanders/Burkhard Kruse	B7.0 F48
EfSa-Accessoires Hr. Efresya Yanardag	B7.0 D25	LEONARDIarte by ROBERTO LEONARDI	B7.0 D34
Eisenhans – Reinhard Wolter GbR	B7.0 C60	GEORG Jerzy Lesniak	B7.0 F46
Christian Emig Schmuck & Mineralien Estelle e.K.	B7.0 D14	Lizas GmbH & Co. KG	B7.0 E35
Estelle Silver – Tanja Baur	B7.0 F51	Lorena, RB-Schmuckproduktions GmbH	B7.0 F27
Etnos - Sascha Kayser	B7.0 C51	LuLu Deco GmbH	B7.0 E36
Eydl Wood Jewelry GesbR	B7.0 E32	Madame Butterfly Modenschmuck Einzel- und Großhandels GmbH	B7.0 D37
Fashion Company Aps	B7.0 G31	Madness	
Faustmann Hüte & Mützen e.K.	B7.0 C23	The Nature Textile Company GmbH	B7.0 D62
Fiebig GmbH & Co. KG	B7.0 E49	MAJ STOUGAARD	B7.0 F38
filz:g-schenke	B7.0 A45	MareSchmuck OHG	B7.0 F29
Flomax Naturmode GmbH	B7.0 B56	Masbelleza - Annika Müller	B7.0 A47
Fortschritt-Berlin e.K.	B7.0 C53	McBURN / Art GmbH	B7.0 A46
Funny Girl Z. Hill	B7.0 C52	McRon – Ronald Weber e.K.	B7.0 E62
		Me Lady B.V.	B7.0 D20
		mekhada – Irmtraud Schmidt	B7.0 B19
		MELA	B7.0 B42

Halle B7 Hall B7

Schmuck & Mode
Jewellery & Fashion

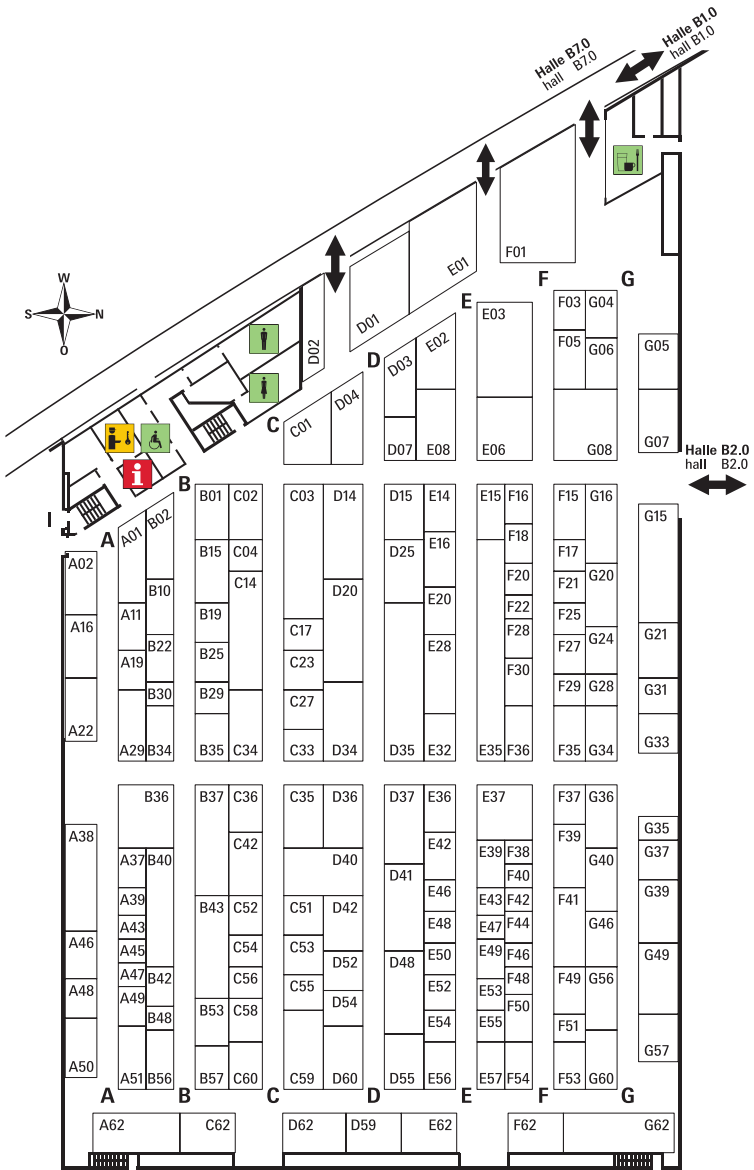

Stand 5. 12. 2017

Detlef Menard P&A	B7.0 F22	umjubelt by Kokopelli	B7.0 C14
Mertens Import- Export GmbH & Co. KG	B7.0 G08	Inh. Kerstin Wein	B7.0 C17
MN-TRENDS Markus Nitsch	B7.0 B43	Unik Collection Gunda Bieber	B7.0 F16
Mystic Maya Verónica Lara Castillo	B7.0 F35	Michael Utzerath GmbH	B7.0 G15
Namaste Anke Dessauer	B7.0 B30	Agentur VE&TO Concept	B7.0 D42
Natursteinschmuck Uta Ottmar	B7.0 A11	Norbert Velten Edelsteine e.K.	B7.0 G33
Nepalaya focused on fair (Mode & Filz Accessoires)	B7.0 F50	Willi Weber & Sohn GmbH	B7.0 G34
Nikos Kalogeropoulos Schmuck	B7.0 A50	Heinrich Wilkens Handelsvertretung	B7.0 E47
Noble Wilde New Zealand	B7.0 E55	Yam Yam Fashion	B7.0 B36
Nordschmuck Produktions- und Vertriebsgesellschaft mbH	B7.0 G06	Christian Behr GmbH	B7.0 G37
Overhues & Schüssler GmbH & Co.KG	B7.0 D41	Marcin Zaremski	B7.0 G37
PAM	B7.0 F21	Zo-Zi Collection UG	B7.0 C27
PEES Accessoires GmbH	B7.0 C01		
Pilgrim Export ApS	B7.0 E16		
Pink City e.K.	B7.0 F05		
PLATA PA'TI Jörg Wilitzki	B7.0 D07		
pos.sei.mo Marianne Birkenfeld	B7.0 D54		
Possum UG	B7.0 E14		
Praechtlig-Berlin			
Modeagentur Christian Neubauer	B7.0 C55		
Schalportal / Philipp Prekopp	B7.0 A49		
Quinn Scheurle GmbH	B7.0 E53		
Rena-Design Inh. Rena Gerrits	B7.0 A48		
Marco Schreier			
Mineralienhandlung GmbH	B7.0 G40		
S. Schweikardt Moden GmbH	B7.0 D60		
SeaBright GmbH	B7.0 E57		
Senatex GmbH	B7.0 C36		
SENCE Copenhagen			
Priess Ettema Ning AG	B7.0 E15		
Shaghafi GmbH	B7.0 D35		
SHOWROOM 019°	B7.0 D40		
Siddhartha	B7.0 G05		
Siemonsen Schmuckgroßhandel			
Michael Staack e.K.	B7.0 E48		
Silber für Schmuck – Gudrun Haug	B7.0 G04		
SILBERPFEIL Lübeck	B7.0 B02		
Silk Route V.O.F.	B7.0 C42		
Silverplanet	B7.0 G28		
Soulkathrine GmbH & Co. KG	B7.0 E54		
SoWHAT Bag & Jewelry	B7.0 A39		
Spiegelbild Leo Lander	B7.0 B22		
Mineralien- u. Schmuckhandlung			
Frank Steinbach & Co. OHG	B7.0 G20		
Steindesign GmbH	B7.0 G16		
LILLIS STEINE Wan-Hong Janneschitz	B7.0 G39		
Stenzhorn-Edelsteine	B7.0 A01		
Step by Step Design GmbH	B7.0 E56		
Stephisimo Stephan Singer e.K.	B7.0 D03		
Stikkelorum Accessoires			
Inh. Paul Stikkelorum	B7.0 F18		
Stones in Style VOF	B7.0 F25		
Storch-Schmuck	B7.0 E42		
Stulpenkult	B7.0 B57		
Sun Enterprises BV	B7.0 E39		
SUN Kaschmir-Textilien GmbH	B7.0 C54		
Terré Spirit of Stones			
Inh. Frau Susanne Kern	B7.0 A37		
Tipico – eigenArt – J. Trenker	B7.0 F37		
Trendwerkk GmbH	B7.0 D04		
Umiwi UG	B7.0 F40		

Halle B7 Hall B7

Schmuck & Mode
Jewellery & Fashion

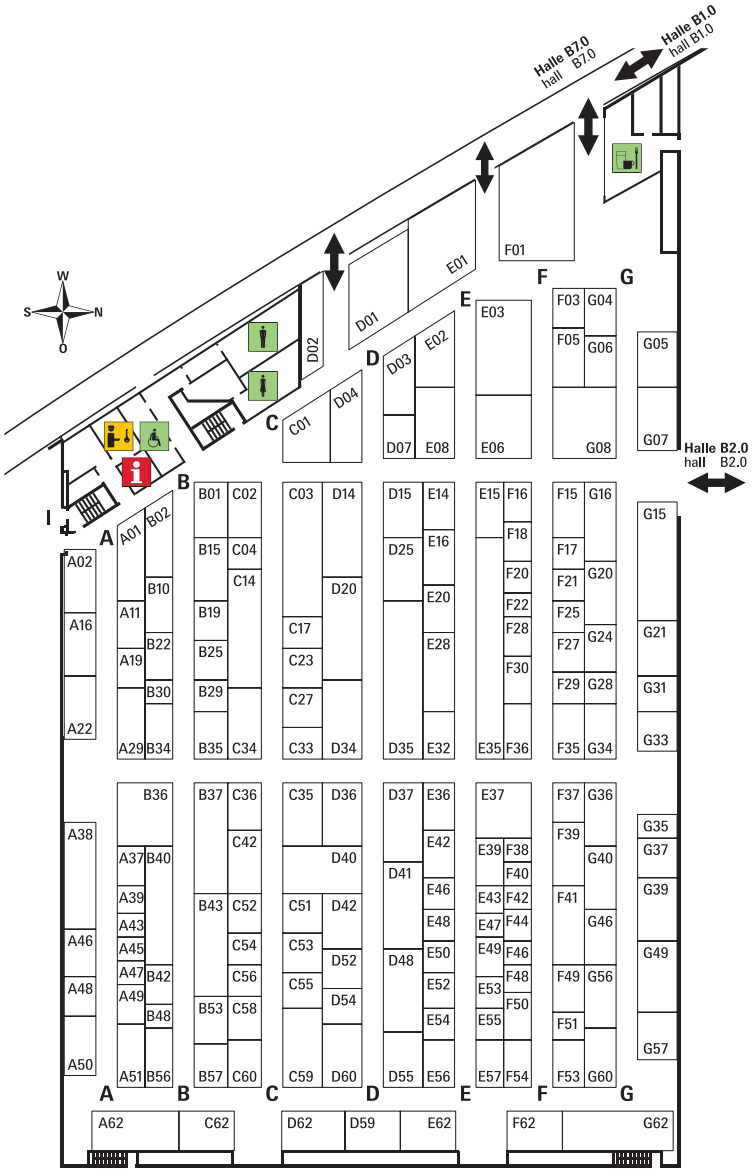

Stand 5. 12. 2017

nach Standnummer

Stenzhorn-Edelsteine	B7.0 A01	Modeagentur Christian Neubauer	B7.0 C55
Accessoires and More	B7.0 A02	Handelsagentur Kleiderprofi	B7.0 C56
Natursteinschmuck Uta Ottmar	B7.0 A11	Jutta Höbermann	B7.0 C58
direkta moden Handelsgesellschaft mbH	B7.0 A16	Diggers Garden	B7.0 C59
AMBRA Schmuck-Atelier	B7.0 A19	Warenhandels GmbH	B7.0 C60
J.U.S.T. Trends GmbH	B7.0 A22	Eisenhans – Reinhard Wolter GbR	B7.0 C62
JustWin Schmuck Design	B7.0 A29	BOOM International Trading GmbH	B7.0 D01
Terré Spirit of Stones		Bahl Collection	B7.0 D03
Inh. Frau Susanne Kern	B7.0 A37	Stephisimo Stephan Singer e.K.	B7.0 D04
R. Klee Edelsteinhandlung e. K.	B7.0 A38	Trendwerkk GmbH	B7.0 D07
SoWHAT Bag & Jewelry	B7.0 A39	PLATA PA'TI Jörg Wilitzki	B7.0 D14
Interior Kunst und Einrichtung		Christian Emig	B7.0 D15
Inhaber Monica Dadder	B7.0 A43	Schmuck & Mineralien	B7.0 D20
filz:g-schenke	B7.0 A45	Amberworld Bernsteinmanufaktur	B7.0 D25
McBURN / Artl GmbH	B7.0 A46	Hamburg Jens von Holt e.K.	B7.0 D25
Masbelleza - Annika Müller	B7.0 A47	Me Lady B.V.	B7.0 D34
Rena-Design Inh. Rena Gerrits	B7.0 A48	EfSa-Accessoires Hr. Efresya Yanardag	B7.0 D36
Schalportal / Philipp Prekopp	B7.0 A49	LEONARDIarte by	B7.0 D37
Nikos Kalogeropoulos Schmuck	B7.0 A50	ROBERTO LEONARDI	B7.0 D40
Kashmir Arts	B7.0 A51	Shaghafi GmbH	B7.0 D41
A. Ahmaddy Tücher und Schals	B7.0 A62	Sabine Hofius Design GmbH	B7.0 D42
Bender-Schmuck Dominik Bender und		Madame Butterfly Modeschmuck	B7.0 D48
Hermann Bender GbR Création Amélie	B7.0 B01	Einzel- und Großhandels GmbH	B7.0 D52
SILBERPFEIL Lübeck	B7.0 B02	SHOWROOM 019°	B7.0 D54
GO2 GmbH	B7.0 B10	Balke Fashion GmbH	B7.0 D55
KT-Schmuckdesign GmbH & Co.KG	B7.0 B15	Overhues & Schüssler GmbH & Co.KG	B7.0 D59
mekhada – Irmtraud Schmidt	B7.0 B19	Agentur VE&TO Concept	B7.0 D60
Spiegelbild Leo Lander	B7.0 B22	Island Wollparadies	B7.0 E01
Aqua dulce v/Janne Lisberg Fisker	B7.0 B25	Australian Fashion House GmbH	B7.0 E02
Max Grubba Galerie Eldorado	B7.0 B29	pos.sei.mo Marianne Birkenfeld	B7.0 E03
Namaste Anke Dessauer	B7.0 B30	Estelle e.K.	B7.0 E06
Hultquist – Copenhagen	B7.0 B34	Himalaya Textilhandels GmbH	B7.0 E08
A. Krikor GmbH Mode-Schmuck	B7.0 B35	S. Schweikardt Moden GmbH	B7.0 E14
Yam Yam Fashion Christian Behr GmbH	B7.0 B36	Madness	B7.0 E15
Colours Cosmetic GmbH	B7.0 B37	The Nature Textile Company GmbH	B7.0 E16
HIGHLIGHT Company Carla Kemper	B7.0 B40	CLARO Handels-GmbH	B7.0 E20
MELA	B7.0 B42	De La Haye Schmuck-Import	B7.0 E28
MN-TRENDS Markus Nitsch	B7.0 B43	DUR Schmuck GmbH	B7.0 E32
Hühnerlounge, Inh. Tina Schuster	B7.0 B48	Campur GmbH	B7.0 E35
HEIDEKÖNIGIN Textilhandels GmbH	B7.0 B53	Bodywings	B7.0 E36
Flomax Naturmode GmbH	B7.0 B56	Possum UG	B7.0 E37
Stulpenkult	B7.0 B57	SENCE Copenhagen	B7.0 E39
PEES Accessoires GmbH	B7.0 C01	Priess Ettema Ning AG	B7.0 E42
Katahati, Sabine Krummradt	B7.0 C02	Pilgrim Export ApS	B7.0 E43
Goldline GmbH	B7.0 C03	Go Dutch Label B.V.	B7.0 E46
KABUKI Country KG	B7.0 C04	Culture Mix B.V.	B7.0 E47
umjubelt by Kokopelli	B7.0 C14	Eydl Wood Jewelry GesBR	B7.0 E48
Inh. Kerstin Wein	B7.0 C17	Lizas GmbH & Co. KG	B7.0 E49
Faustmann Hüte & Mützen e.K.	B7.0 C23	LuLu Deco GmbH	B7.0 E50
Zo-Zi Collection UG	B7.0 C27	Ariana Lapis e.K.	B7.0 E52
Gerdis Koch e.K.	B7.0 C33	Sun Enterprises BV	B7.0 E53
Hizkiahu Kupfer	B7.0 C34	Storch-Schmuck	B7.0 E54
BMS Bernd-Michael		GSK Gerhard Sagner GmbH & Co. KG	B7.0 E55
Schröder Sailing Wear GmbH	B7.0 C35	Bunte Wolken -	
Senatex GmbH	B7.0 C36	Schönes aus Asien Yingwen Chen	
Silk Route V.O.F.	B7.0 C42	Heinrich Wilkens Handelsvertretung	
Etnos - Sascha Kayser	B7.0 C51	Siemonsen Schmuckgroßhandel	
Funny Girl Z. Hill	B7.0 C52	Michael Staack e.K.	
Fortschritt-Berlin e.K.	B7.0 C53	Fiebig GmbH & Co. KG	
SUN Kaschmir-Textilien GmbH	B7.0 C54	Tom Joule	
Praechtig-Berlin		Creative Minds Revive B.V.	
		Quinn Scheurle GmbH	
		Soukathrine GmbH & Co. KG	
		Noble Wilde New Zealand	