

Hallenpläne

Hall floor plans

Halle Hall	Seite Page
A1	232
A2	238
A3	242
A4	250
B1.0	256
B1.1	260
B2	262
B3	266
B4	268
B5	270
B7	274

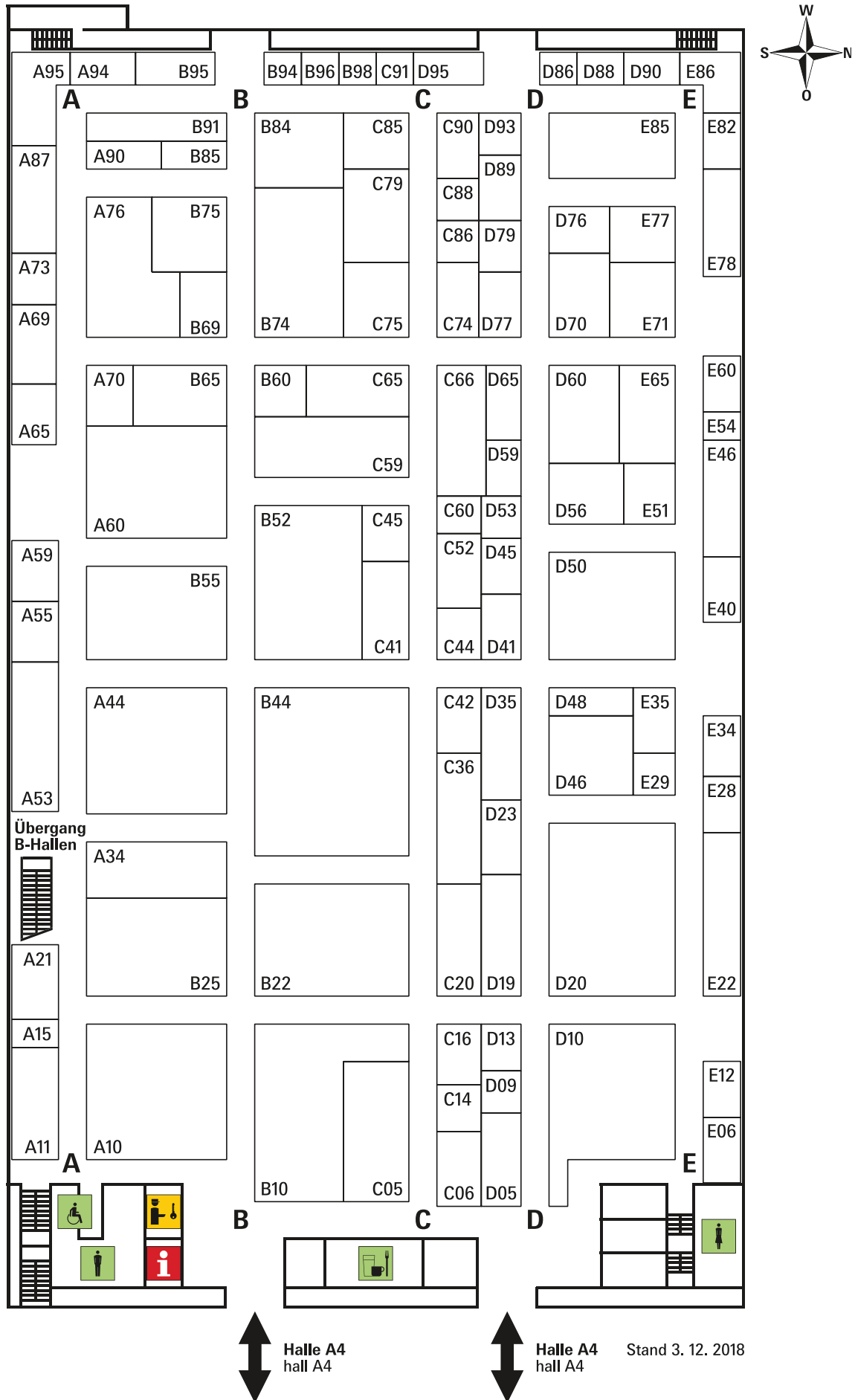

alphabetisch

Abels & Abels Inhaber: Mario Abels	A1.0 C90	Heitmann Felle GmbH	A1.0 B69
Affari AB	A1.0 B22	hell & gut M. O. Leuchten GmbH	A1.0 E06
albert L. (punkt) Sandra Schröder	A1.0 D50	Hirschglück Thomas Eckert	A1.0 D95
AM-Design Floristik GmbH	A1.0 D10	Hoff-Interieur GmbH & Co. KG	A1.0 B10
Ambiente Europe B.V.	A1.0 D60	Joachim Holländer	A1.0 C65
Ambiente Haus GmbH	A1.0 A11	HOLZWURM	A1.0 C36
Andersson Supply		Hossner Heimtex GmbH	A1.0 C52
v/ Birgitte Andersson	A1.0 E77	IHR Ideal Home Range GmbH	A1.0 A34
Andrews Living Rooms		invero GmbH	A1.0 D35
Inh. Andrew Finch	A1.0 D45	italB. Birgit Jörgens (Einzelfirma)	A1.0 E34
APS glass & bar supply GmbH	A1.0 E12	Jeanne d'Arc Living ApS	A1.0 D56
Atelier Heidi Inh. Heidi Metzner e.K.	A1.0 D13	JET Papier GmbH	A1.0 E86
Baden GmbH	A1.0 B55	Ju-Lein GmbH	A1.0 D93
Bambus Dreams GmbH - TRAMARK	A1.0 B60	Kaheku Schönes Wohnen GmbH	A1.0 B52
Bastion Collections BV	A1.0 E46	Evelyn Kahle GmbH	A1.0 C44
Bella Tavola Inh. Antonio Fernandes	A1.0 A69	Koustrup & Co. ApS	A1.0 C86
Bottlelight Company -		Krasilnikoff A/S	A1.0 D19
Dr. Kitzenmaier, Leuchten	A1.0 C91	Kreidefarben-Manufaktur und Handel e.K.	A1.0 D88
Breitner GmbH Kunstgewerbe	A1.0 A87	Kunstindustrien ApS	A1.0 B85
Busatti s.r.l.	A1.0 E51	La Casa di Caesar GmbH	A1.0 B74
BY ROOM	A1.0 E71	La Finesse Lager ApS	A1.0 B65
Candle Factory, Dennis Gödeke e.K.	A1.0 C74	la Vida GmbH/Geschenk für Dich	A1.0 B84
Clayre & Eef B.V.	A1.0 E85	Lavinia-collection Germany GmbH & Co. KG	A1.0 C79
Cotonway Foutas SAS	A1.0 D79	linckx.® Ute Linck-Borys	A1.0 B94
Cotton Ball Lights		Lovely Linen	A1.0 C41
Inhaberin: Marlot Meinema	A1.0 A59	Mea-Living GmbH	A1.0 B91
D&T Design Hamburg GmbH	A1.0 D05	Meander BV	A1.0 C66
Danishville, M.K. Jacobsen	A1.0 D65	meori GmbH & Co. KG	A1.0 B96
DP Danmark ApS	A1.0 A70	MOCCO Made Of Cotton CO.	A1.0 C88
Silke Daut	A1.0 C75	Handelsagentur Thomas Mrowka	A1.0 C74
DE MiM Illustration & Design		Münder-Email GmbH	A1.0 B95
Miriam Kramer	A1.0 E28	Exotica Cor Mulder GmbH	A1.0 A10
Decor Wolfgang Spiegler	A1.0 A69	Näsgrängsgarden AB	A1.0 D48
Gabriele Gräfin Deym –		Nakina GmbH	A1.0 C60
british-living Brookpace Lascelles	A1.0 D77	Nature and Style Wohnkultur Import GmbH	A1.0 D50
Done.® by Karabel Home Company GmbH	A1.0 C45	NATURES Collection A/S	A1.0 C06
Ekelund, Linneväveriet i Horred AB	A1.0 C16	Piffany Copenhagen ApS	A1.0 D09
Farbenfreunde GmbH	A1.0 E82	PLINT A/S	A1.0 A65
Stefano Ferrante - Bella Casa	A1.0 B98	Sander GmbH & Co. KG	
Five Minutes B.V.	A1.0 D53	TABLE + HOME	A1.0 D76
Flair Vitrine Glas Porzellan Handels GmbH	A1.0 D41	Scanlux Packaging A/S	A1.0 E78
FUHRHOME ApS	A1.0 D70	Jürgen Schleiß Konfektion	A1.0 E35
GAMA Import-Export		Schneider & Friends	
Inh. Margareta Garba	A1.0 A94	Inh. Franz J. Schneider	A1.0 C42
Kunstgewerbe Gehlmann e.K.	A1.0 B25	Schweden Produkte	A1.0 C14
La Casa Gerber	A1.0 E29	Schwedenstil OHG	A1.0 A55
GILDE HANDWERK		AVENUE38 -	
Macrander GmbH & Co. KG	A1.0 A44	Guido EW Schwettmann	A1.0 D59
GILDE HANDWERK		Porzellanfabriken	
Macrander GmbH & Co. KG	A1.0 A53	Christian Seltmann GmbH	A1.0 B75
Gizas GmbH	A1.0 A73	SIGNATURE HOME COLLECTION GmbH	A1.0 A21
Glasbar	A1.0 C85	Solwang Design Denmark Danishville	A1.0 D65
Glaskönig Peter Theiler	A1.0 E60	Soncek, d.o.o.	A1.0 D89
GreenGate Europe A/S	A1.0 C05	Steen Design Willo Steen	A1.0 C20
Hazenkamp Furnitures BV.	A1.0 A76	Dr. J. Volkmar Stöber	A1.0 E22

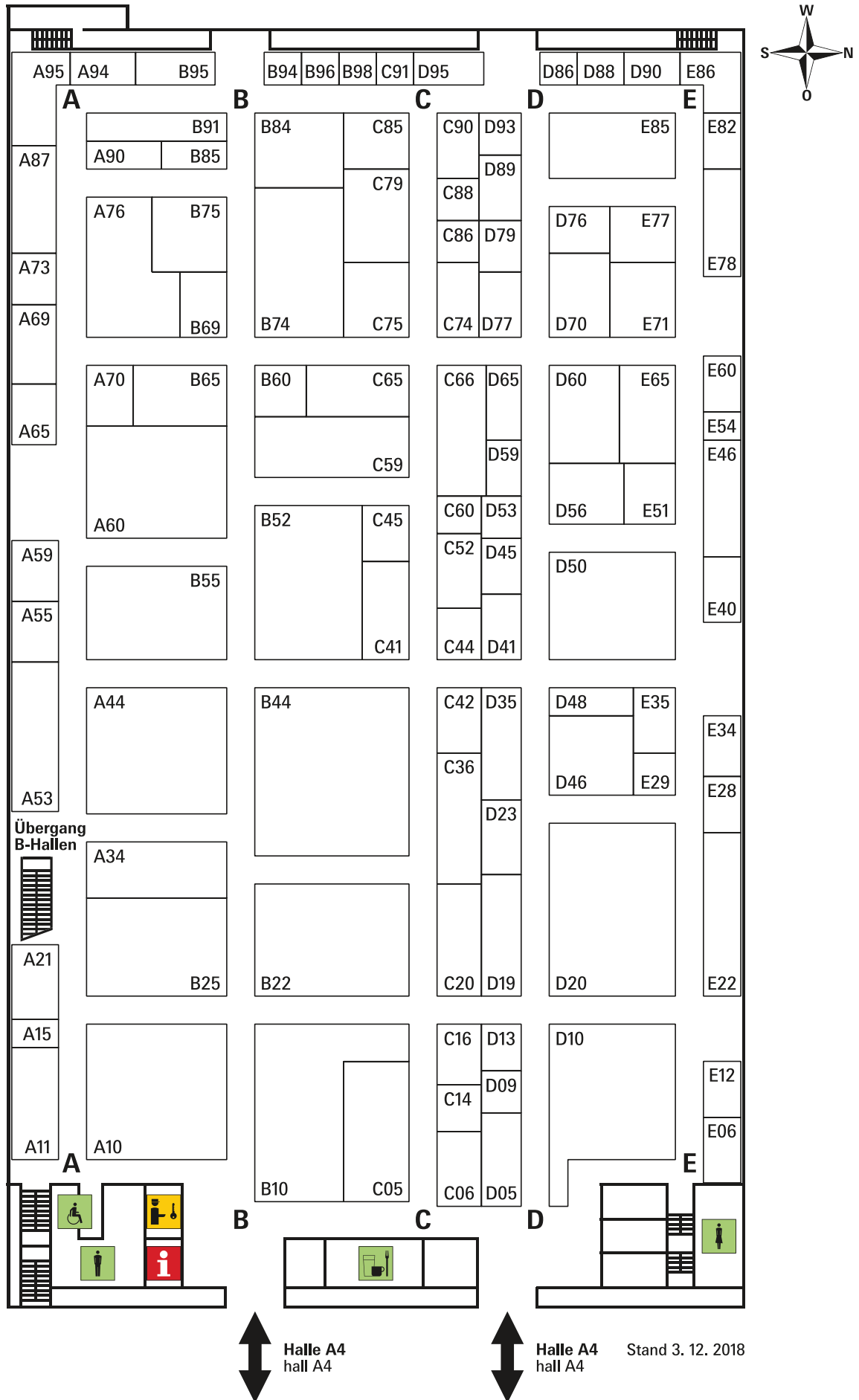

Stand 3. 12. 2018

SweetDesign by Nala	
Christian Euwens	A1.0 E40
TAFELGUT	A1.0 E65
Thanks A Lot Inhaber: Alexander Kaup	A1.0 D86
TheMoshi AB	A1.0 C59
Erika Vaitkute - Leinen aus Litauen	A1.0 D50
van Deurs Danmark	A1.0 D46
Vintage Designer	A1.0 D90
VL Home Collection GbR	A1.0 A90
Werner Voß GmbH	
Handel & Marketing	A1.0 D20
Walter & Prediger GmbH & Co. KG	A1.0 A95
Westfalenstoffe AG	A1.0 D23
wirework - contemporary	
south african handcraft	
Inh. Michelle Schingerlin	A1.0 E54
Wohnmanufactur Grünberger S.r.o.	A1.0 A60
Handelsvertretungen Kerstin Wollner	A1.0 A69
G. Wurm GmbH + Co. KG	A1.0 B44

nach Standnummer

Exotica Cor Mulder GmbH	A1.0 A10
Ambiente Haus GmbH	A1.0 A11
SIGNATURE HOME COLLECTION GmbH	A1.0 A21
IHR Ideal Home Range GmbH	A1.0 A34
GILDE HANDWERK	
Macrander GmbH & Co. KG	A1.0 A44
GILDE HANDWERK	
Macrander GmbH & Co. KG	A1.0 A53
Schwedenstil OHG	A1.0 A55
Cotton Ball Lights	
Inhaberin: Marlot Meinema	A1.0 A59
Wohnmanufactur Grünberger S.r.o.	A1.0 A60
PLINT A/S	A1.0 A65
Bella Tavola Inh. Antonio Fernandes	A1.0 A69
Decor Wolfgang Spiegler	A1.0 A69
Handelsvertretungen Kerstin Wollner	A1.0 A69
DP Danmark ApS	A1.0 A70
Gizadas GmbH	A1.0 A73
Hazenkamp Furnitures BV.	A1.0 A76
Breitner GmbH Kunstgewerbe	A1.0 A87
VL Home Collection GbR	A1.0 A90
GAMA Import-Export	
Inh. Margareta Garba	A1.0 A94
Walter & Prediger GmbH & Co. KG	A1.0 A95
Hoff-Interieur GmbH & Co. KG	A1.0 B10
Affari AB	A1.0 B22
Kunstgewerbe Gehlmann e.K.	A1.0 B25
G. Wurm GmbH + Co. KG	A1.0 B44
Kaheku Schönes Wohnen GmbH	A1.0 B52
Baden GmbH	A1.0 B55
Bambus Dreams GmbH - TRAMARK	A1.0 B60
La Finesse Lager ApS	A1.0 B65
Heitmann Felle GmbH	A1.0 B69
La Casa di Caesar GmbH	A1.0 B74

Porzellanfabriken	
Christian Seltmann GmbH	A1.0 B75
la Vida GmbH/Geschenk für Dich	A1.0 B84
Kunstindustrien ApS	A1.0 B85
Mea-Living GmbH	A1.0 B91
linckx.® Ute Linck-Borys	A1.0 B94
Münder-Email GmbH	A1.0 B95
meori GmbH & Co. KG	A1.0 B96
Stefano Ferrante - Bella Casa	A1.0 B98
GreenGate Europe A/S	A1.0 C05
NATURES Collection A/S	A1.0 C06
Schweden Produkte	A1.0 C14
Ekelund, Linneväveriet i Horred AB	A1.0 C16
Steen Design Willo Steen	A1.0 C20
HOLZWURM	A1.0 C36
Lovely Linen	A1.0 C41
Schneider & Friends	
Inh. Franz J. Schneider	A1.0 C42
Evelyn Kahle GmbH	A1.0 C44
Done.® by Karabel Home	
Company GmbH	A1.0 C45
Hossner Heimtex GmbH	A1.0 C52
TheMoshi AB	A1.0 C59
Nakina GmbH	A1.0 C60
Joachim Holländer	A1.0 C65
Meander BV	A1.0 C66
Candle Factory, Dennis Gödeke e.K.	A1.0 C74
Handelsagentur Thomas Mrowka	A1.0 C74
Silke Daut	A1.0 C75
Lavinia-collection Germany	
GmbH & Co. KG	A1.0 C79
Glasbar	A1.0 C85
Koustrup & Co. ApS	A1.0 C86
MOCCO Made Of Cotton CO.	A1.0 C88
Abels & Abels Inhaber: Mario Abels	A1.0 C90
Bottlelight Company -	
Dr. Kitzenmaier, Leuchten	A1.0 C91
D&T Design Hamburg GmbH	A1.0 D05
Piffany Copenhagen ApS	A1.0 D09
AM-Design Floristik GmbH	A1.0 D10
Atelier Heidi Inh. Heidi Metzner e.K.	A1.0 D13
Krasilnikoff A/S	A1.0 D19
Werner Voß GmbH	
Handel & Marketing	A1.0 D20
Westfalenstoffe AG	A1.0 D23
invero GmbH	A1.0 D35
Flair Vitrine Glas Porzellan	
Handels GmbH	A1.0 D41
Andrews Living Rooms	
Inh. Andrew Finch	A1.0 D45
van Deurs Danmark	A1.0 D46
Näsgrängsgarden AB	A1.0 D48
albert L. (punkt) Sandra Schröder	A1.0 D50
Nature and Style Wohnkultur Import	
GmbH	A1.0 D50
Erika Vaitkute - Leinen aus Litauen	A1.0 D50
Five Minutes B.V.	A1.0 D53
Jeanne d'Arc Living ApS	A1.0 D56
AVENUE38 - Guido EW Schwettmann	A1.0 D59

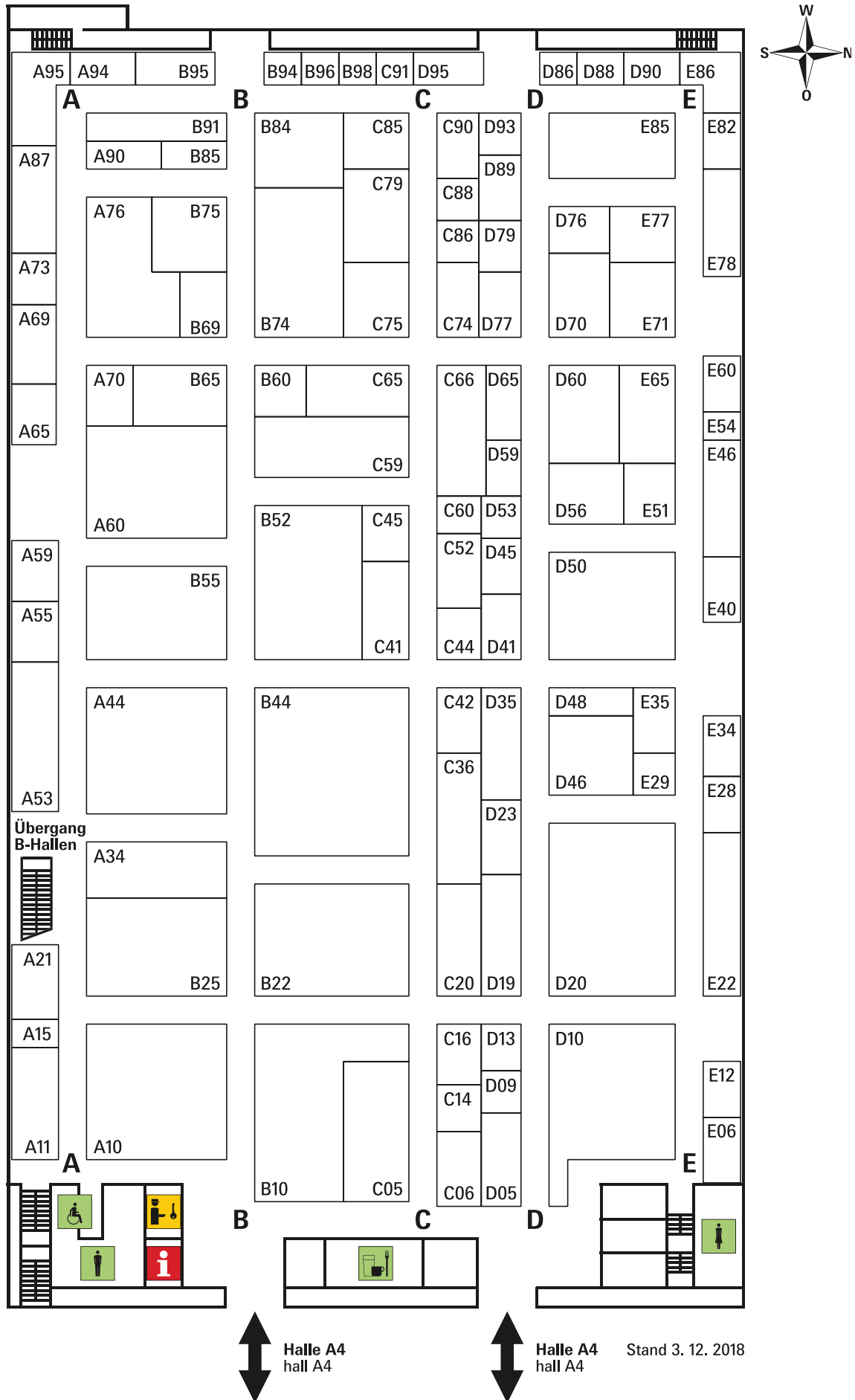

Stand 3. 12. 2018

Ambiente Europe B.V.	A1.0 D60
Danishville, M.K. Jacobsen	A1.0 D65
Solwang Design Denmark Danishville	A1.0 D65
FUHRHOME ApS	A1.0 D70
Sander GmbH & Co. KG	
TABLE + HOME	A1.0 D76
Gabriele Gräfin Deym – british-living Brookpace Lascelles	A1.0 D77
Cotonway Foutas SAS	A1.0 D79
Thanks A Lot Inhaber: Alexander Kaup	A1.0 D86
Kreidefarben-Manufaktur und Handel e.K.	A1.0 D88
Soncek, d.o.o.	A1.0 D89
Vintage Designer	A1.0 D90
Ju-Lein GmbH	A1.0 D93
Hirschglück Thomas Eckert	A1.0 D95
hell & gut M. O. Leuchten GmbH	A1.0 E06
APS glass & bar supply GmbH	A1.0 E12
Dr. J. Volkmar Stöber	A1.0 E22
DE MiM Illustration & Design	
Miriam Kramer	A1.0 E28
La Casa Gerber	A1.0 E29
italB. Birgit Jörgens (Einzelfirma)	A1.0 E34
Jürgen Schleiß Konfektion	A1.0 E35
SweetDesign by Nala Christian Euwens	A1.0 E40
Bastion Collections BV	A1.0 E46
Busatti s.r.l.	A1.0 E51
wirework - contemporary south african handcraft	
Inh. Michelle Schingerlin	A1.0 E54
Glaskönig Peter Theiler	A1.0 E60
TAFELGUT	A1.0 E65
BY ROOM	A1.0 E71
Andersson Supply v/ Birgitte Andersson	A1.0 E77
Scanlux Packaging A/S	A1.0 E78
Farbenfreunde GmbH	A1.0 E82
Clayre & Eef B.V.	A1.0 E85
JET Papier GmbH	A1.0 E86

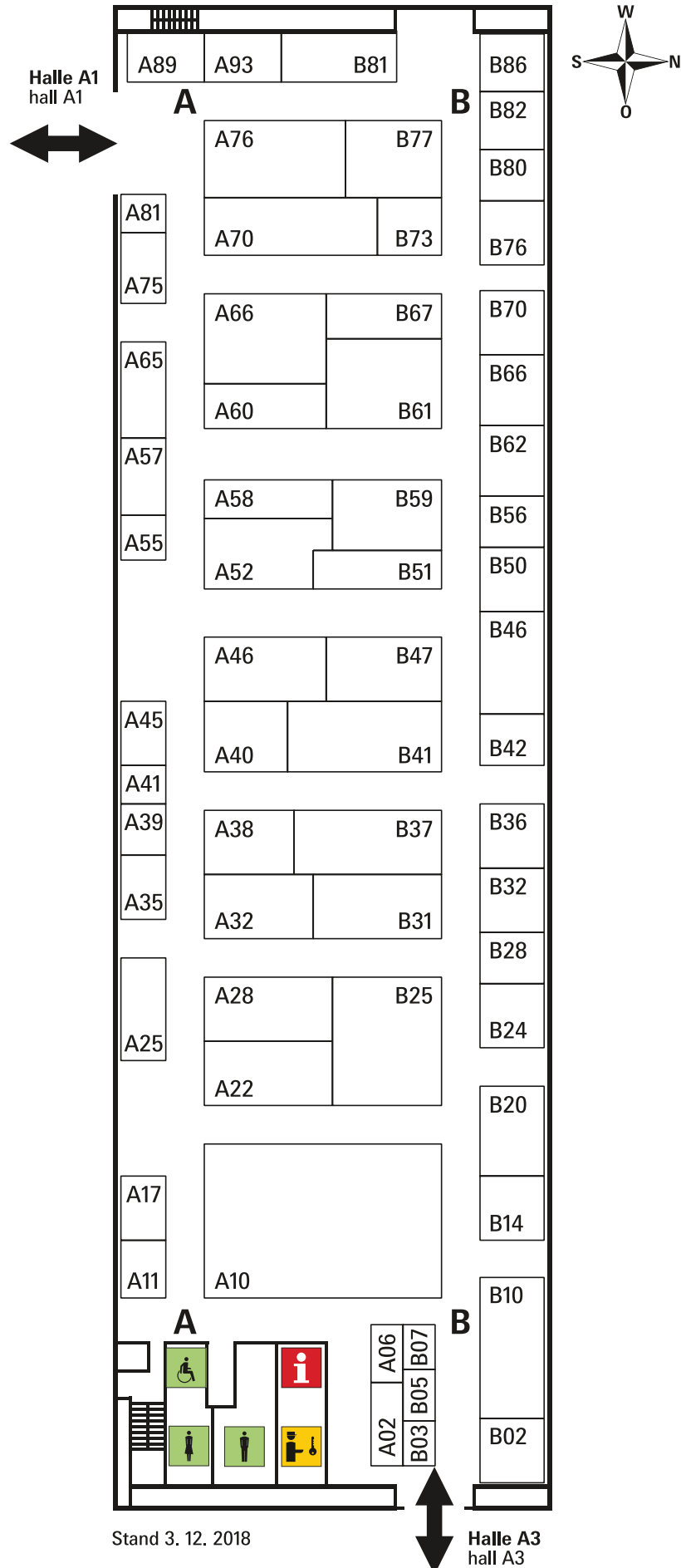

alphabetisch

ABC - Glückwunschkarten	
A. Boss + Co. AG	A2.0 B37
Allegro Raimund Epping	A2.0 B46
Asmodee GmbH	A2.0 A06
Baier & Schneider GmbH & Co. KG	A2.0 A10
Ballaballa GmbH	A2.0 A89
Bekking & Blitz Uitgevers B.V.	A2.0 A39
Bertoy-Vekemans BVBA	A2.0 B62
Bookchair Vertrieb Inh. Helmut Hetzer	A2.0 A02
Colibri System GmbH	A2.0 A40
Cornelissen naTierliche Geschenke GmbH & Co. KG	A2.0 A70
DDKado - Isa Cards & Gifts	A2.0 A75
D&R DENKRIESEN UG (haftungsbeschränkt)	A2.0 B82
Werner Dorsch GmbH	A2.0 B02
DURABLE Hunke & Jochheim GmbH & Co. KG	A2.0 B14
edding Vertrieb GmbH	A2.0 B10
Studio B Glückwunschkarten GmbH / EigenART	A2.0 B76
ExaClair GmbH	A2.0 B41
FÜRNIS Inh. Wolfgang Fürnwein	A2.0 B05
Gebro B.V.	A2.0 B59
Gerstenberg Verlag GmbH & Co. KG	A2.0 B28
Goldbek Verlag GmbH	A2.0 B77
EDITION GOLLONG GmbH	A2.0 A38
Gutsch Verlag GmbH & Co. KG	A2.0 A28
HERGO Creation GmbH	A2.0 B67
Laurence King Verlag GmbH	A2.0 B56
Kiwi Media GmbH	A2.0 A81
kleine prints GmbH	A2.0 B07
Korsch Verlag GmbH & Co. KG	A2.0 B31
Lang & Schrödter Verlag	A2.0 A45
Lilliputiens S.A.	A2.0 B62
LM Cards Srl	A2.0 B86
Lyra-Bleistift-Fabrik GmbH & Co. KG	A2.0 A65
Matthies Spielprodukte GmbH + Co. KG	A2.0 B70
Melissa & Doug LLC	A2.0 A52
Milchmania UG	A2.0 B03
Misc Group VOF	A2.0 A57
NICI GmbH	A2.0 A66
Nostalgic-Art Merchandising GmbH	A2.0 B51
Verlag Friedrich Oetinger GmbH	A2.0 A32
Online Schreibgeräte GmbH	A2.0 B36
PAGNA GmbH & Co. KG	A2.0 B14
Hartley & Marks Publishers Ltd. - Paperblanks	A2.0 B50
Paperholic all `bout paper	A2.0 A55
Pappnase & Co. GmbH	A2.0 A46
Uwe Pein seit 1981 Handelsvertretung CDH	A2.0 A58
Pelikan Vertriebsgesellschaft mbH & Co. KG	A2.0 B25
Pentel Bürobedarf-Handelsgesellschaft mbH	A2.0 B80
Pilot Pen (Deutschland) GmbH	A2.0 B24

Rössler Papier GmbH & Co. KG	A2.0 B47
Sagro Verlag, Günter Grothkopp	A2.0 A35
Handelskontor SANUK GmbH	A2.0 A17
Udo Schmidt GmbH & Co. KG	A2.0 A76
Schneider Novus Vertriebs GmbH	A2.0 A25
Schöning GmbH & Co. KG	A2.0 B73
Klaus Schürmann Handelsvertretungen CDH	A2.0 A60
Smart Toys and Games GmbH	A2.0 B32
Souza! - Phanine B.V.	A2.0 A93
Städtler MediaMarketing GmbH	A2.0 B42
Taurus – Kunstkarten GmbH	A2.0 A22
Trendhaus Handelsgesellschaft mbH	A2.0 B61
TST T-Shirt-Total GmbH	A2.0 B66
Usborne Verlag / dtv Verlagsgesellschaft mbH & Co. KG	A2.0 A11
Veloflex Carsten Thormählen GmbH & Co. KG	A2.0 B20
VZ Trend Goods GmbH	A2.0 B81
WUNDERWORT Angela Gwinner	A2.0 A41
WUP oHG	A2.0 A46

nach Standnummer

Bookchair Vertrieb Inh. Helmut Hetzer	A2.0 A02
Asmodee GmbH	A2.0 A06
Baier & Schneider GmbH & Co. KG	A2.0 A10
Usborne Verlag / dtv Verlagsgesellschaft mbH & Co. KG	A2.0 A11
Handelskontor SANUK GmbH	A2.0 A17
Taurus – Kunstkarten GmbH	A2.0 A22
Schneider Novus Vertriebs GmbH	A2.0 A25
Gutsch Verlag GmbH & Co. KG	A2.0 A28
Verlag Friedrich Oetinger GmbH	A2.0 A32
Sagro Verlag, Günter Grothkopp	A2.0 A35
EDITION GOLLONG GmbH	A2.0 A38
Bekking & Blitz Uitgevers B.V.	A2.0 A39
Colibri System GmbH	A2.0 A40
WUNDERWORT Angela Gwinner	A2.0 A41
Lang & Schrödter Verlag	A2.0 A45
Pappnase & Co. GmbH	A2.0 A46
WUP oHG	A2.0 A46
Melissa & Doug LLC	A2.0 A52
Paperholic all `bout paper	A2.0 A55
Misc Group VOF	A2.0 A57
Uwe Pein seit 1981 Handelsvertretung CDH	A2.0 A58
Klaus Schürmann Handelsvertretungen CDH	A2.0 A60
Lyra-Bleistift-Fabrik GmbH & Co. KG	A2.0 A65
NICI GmbH	A2.0 A66
Cornelissen naTierliche Geschenke GmbH & Co. KG	A2.0 A70
DDKado - Isa Cards & Gifts	A2.0 A75
Udo Schmidt GmbH & Co. KG	A2.0 A76
Kiwi Media GmbH	A2.0 A81

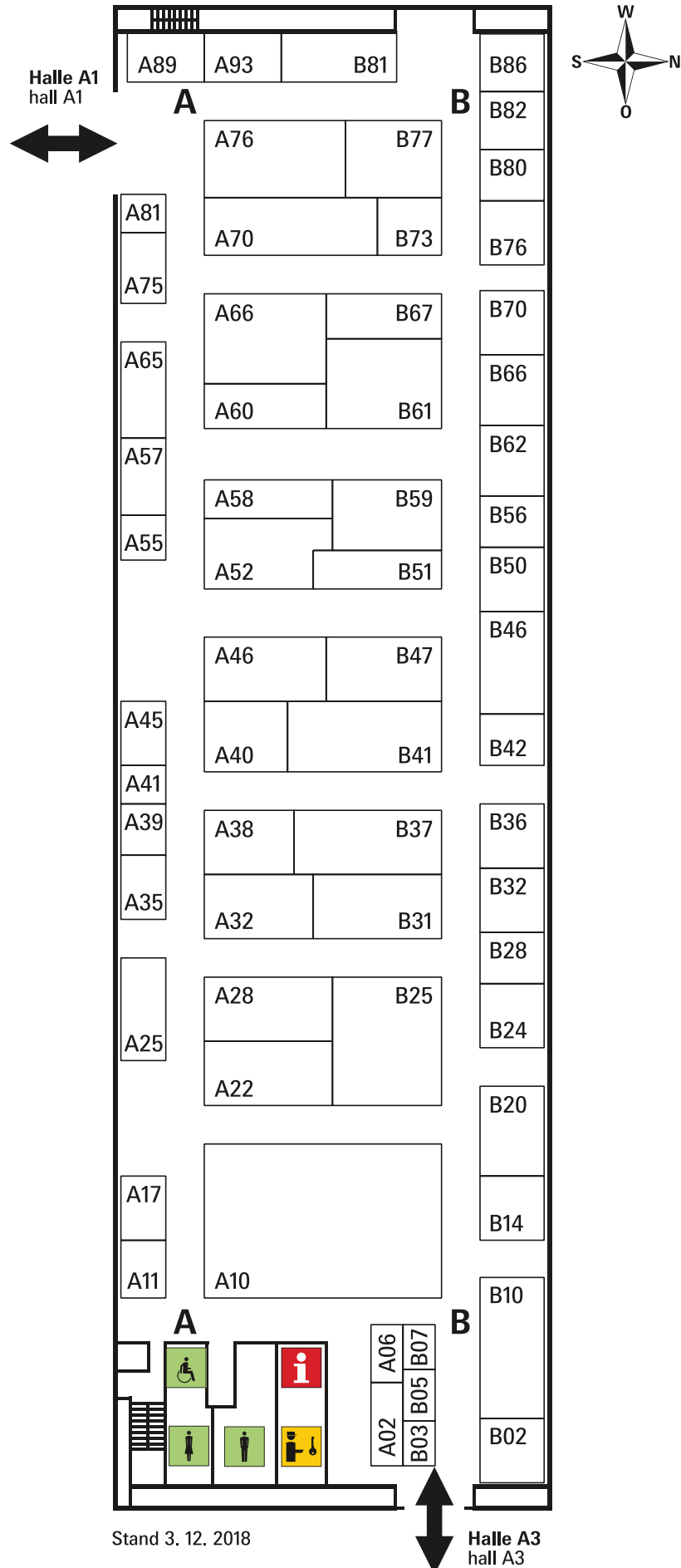

Stand 3. 12. 2018

Halle A3
hall A3

Ballaballa GmbH	A2.0 A89
Souza! - Phanine B.V.	A2.0 A93
Werner Dorsch GmbH	A2.0 B02
Milchmania UG	A2.0 B03
FÜRNIS Inh. Wolfgang Fürnwein	A2.0 B05
kleine prints GmbH	A2.0 B07
edding Vertrieb GmbH	A2.0 B10
DURABLE Hunke & Jochheim GmbH & Co. KG	A2.0 B14
PAGNA GmbH & Co. KG	A2.0 B14
Veloflex Carsten Thormählen GmbH & Co. KG	A2.0 B20
Pilot Pen (Deutschland) GmbH	A2.0 B24
Pelikan Vertriebsgesellschaft mbH & Co. KG	A2.0 B25
Gerstenberg Verlag GmbH & Co. KG	A2.0 B28
Korsch Verlag GmbH & Co. KG	A2.0 B31
Smart Toys and Games GmbH	A2.0 B32
Online Schreibgeräte GmbH	A2.0 B36
ABC - Glückwunschkarten A. Boss + Co. AG	A2.0 B37
ExaClair GmbH	A2.0 B41
Städtler MediaMarketing GmbH	A2.0 B42
Allegro Raimund Epping	A2.0 B46
Rössler Papier GmbH & Co. KG	A2.0 B47
Hartley & Marks Publishers Ltd. - Paperblanks	A2.0 B50
Nostalgic-Art Merchandising GmbH	A2.0 B51
Laurence King Verlag GmbH	A2.0 B56
Gebro B.V.	A2.0 B59
Trendhaus Handelsgesellschaft mbH	A2.0 B61
Bertoy-Vekemans BVBA	A2.0 B62
Lilliputiens S.A.	A2.0 B62
TST T-Shirt-Total GmbH	A2.0 B66
HERGO Creation GmbH	A2.0 B67
Matthies Spielprodukte GmbH + Co. KG	A2.0 B70
Schöning GmbH & Co. KG	A2.0 B73
Studio B Glückwunschkarten GmbH / EigenART	A2.0 B76
Goldbek Verlag GmbH	A2.0 B77
Pentel Bürobedarf- Handelsgesellschaft mbH	A2.0 B80
VZ Trend Goods GmbH	A2.0 B81
D&R DENKRIESEN UG (haftungsbeschränkt)	A2.0 B82
LM Cards Srl	A2.0 B86

Halle A3 Hall A3

Stil & Design / Geschenke & Papeterie
Style & Design / Gifts & Stationery

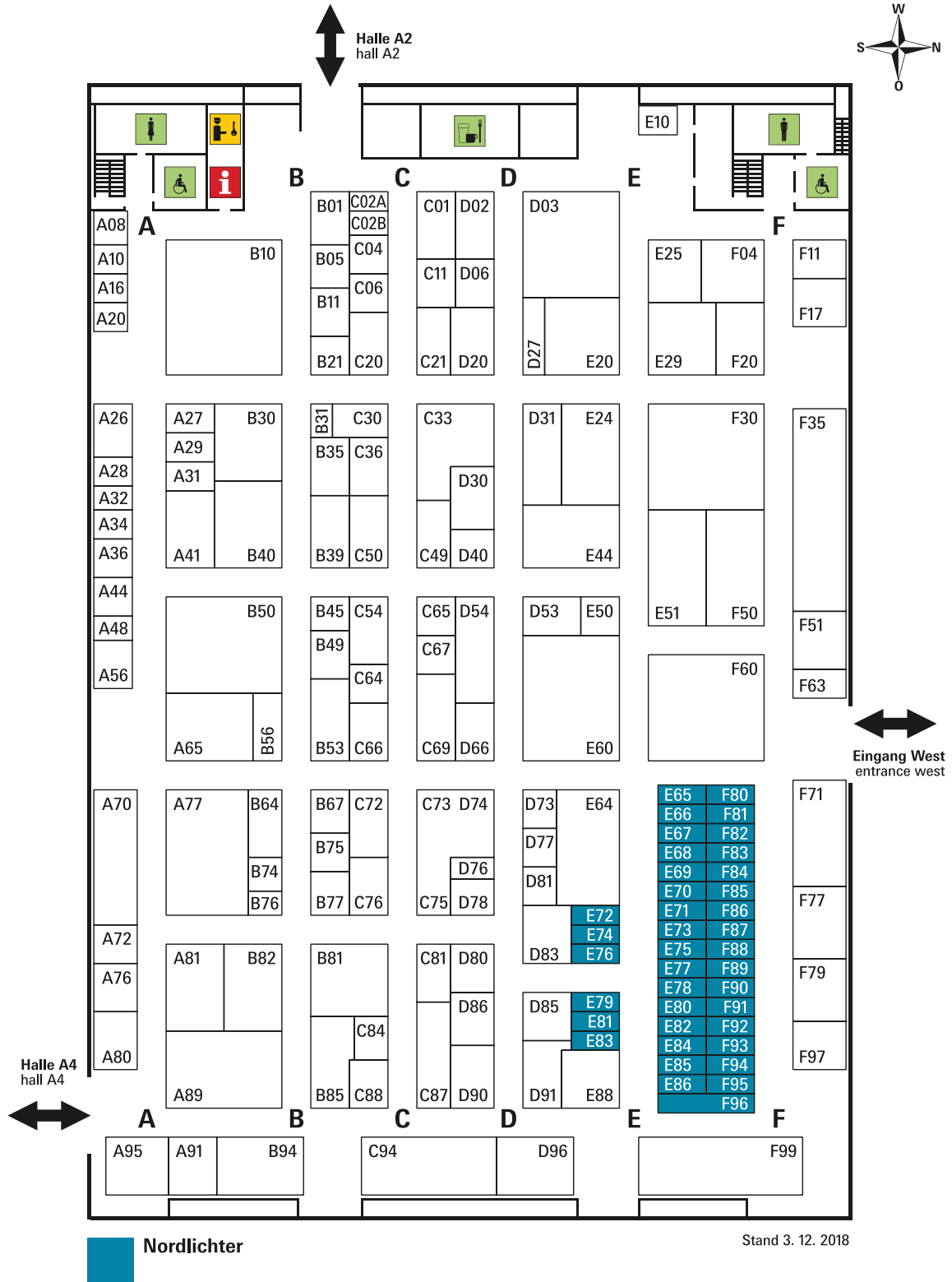

alphabetisch

Acte tre Deutschland GmbH	A3.0 F77	EPOCH Traumwiesen GmbH	A3.0 B39
AHS-Spielzeug GmbH & Co. KG	A3.0 B67	ETISYS Etikettierlösungen GmbH	A3.0 C04
Andrea Verlags GmbH	A3.0 D31	ever&again Inh. Kristina Günther	A3.0 E66
arsEdition GmbH	A3.0 F79	Fantasie4Kids OHG	A3.0 D78
Art à la Card GbR	A3.0 D74	FantasTick Greetings GmbH	A3.0 F20
Augenstolz - Michael Boock	A3.0 A80	Feingeladen	A3.0 F83
AvanCarte GmbH	A3.0 B50	FOND OF GmbH	A3.0 C72
AXSE Axel Semblat e.K.	A3.0 D06	FOX & POET Fuchs & Zips GbR	A3.0 F84
bb Klostermann GmbH	A3.0 C33	Frau Schnobel Grafik	
BCM concept + marketing GmbH	A3.0 E79	Inh. Martina Olonschek	A3.0 F85
beeGoodies-hellogreen GbR	A3.0 E82	Fun Unlimited Products GmbH	A3.0 C20
Berk Esoterik e.K.	A3.0 F50	G.A.W. Gaida's Angel Welt - Daniel Gaida	A3.0 A16
Gebrüder Bertels		GAPYRUS OHG G. Biegert / A. Lohmann-Biegert	
Handelsvertretungen GmbH	A3.0 D96	Buchbinderarbeiten	A3.0 F97
Birgit Bertz - WILD at Art Design	A3.0 E70	Glücksschmiedin - Ulrike Alt	A3.0 A28
BLOOM your message V.O.F.	A3.0 A31	Goldbuch Georg Brückner GmbH	A3.0 E51
BOHEI	A3.0 B21	Grätz Verlag GmbH	A3.0 E44
Roger la Borde	A3.0 A20	Becker & Becker Vertrieb GmbH & Co. KG Grafik Werkstatt	A3.0 E60
Bow & Hummingbird, Inh. Carolin Hennekes	A3.0 A44	HABA - Habermaass GmbH	A3.0 B94
Braun + Company Papierwaren GmbH	A3.0 D96	Hammar Posse	A3.0 E74
Brunnen-Verlag GmbH	A3.0 B35	Klaus Hanfstingl Verlag GmbH	A3.0 F04
meer! Karin Buchholz	A3.0 A36	HANSEKIND GmbH	
Bulla-Manufaktur für schöne Dinge	A3.0 C64	Kindermöbel & Accessoires	A3.0 C76
BUTTcamp Inh.: Ursula Fritz	A3.0 C75	Happy Accessories AB	A3.0 F63
CARLSEN Verlag GmbH	A3.0 F79	Hartung GmbH & Co. KG	A3.0 E20
Carry Bottles	A3.0 B45	H.C.A. Collection Handels-GmbH	A3.0 C50
Casablanca GmbH & Co. KG Modernes Design	A3.0 A70	HELLMANN-VERSAND GMBH	A3.0 D03
Casablanca GmbH & Co. KG Modernes Design	A3.0 A77	HERMA GmbH	A3.0 C06
Cepewa GmbH	A3.0 F60	Hey!Cards GmbH & Co. KG	A3.0 F89
Cityproducts - Dr. Bianca Thierhoff	A3.0 D54	hjärtslag home textiles	A3.0 E76
Collema Wrapping	A3.0 E72	Hjemhavn	A3.0 E81
Coppenrath Verlag GmbH & Co. KG	A3.0 A89	HobbyFun GmbH & Co. KG	A3.0 F99
Crazy Three GmbH	A3.0 B56	holzpost GmbH	A3.0 C73
Creativ Company Deutschland GmbH	A3.0 E88	Indian Lotus Pvt. Ltd.	A3.0 F51
daniels*cards	A3.0 D73	inhoma	A3.0 C49
DANKEBOX	A3.0 F95	Inkognito Gesellschaft für faustdicke Überraschungen mbH	A3.0 B30
dearsoap Inh. Sylvia Woelki	A3.0 E85	Interior Kunst und Einrichtung Inhaber Monica Dadder	A3.0 E80
Depesche Vertrieb GmbH & Co. KG	A3.0 B10	Invento Products & Services GmbH	A3.0 D20
Designkonsorten GbR	A3.0 F82	Inware GmbH	A3.0 A95
die memofaktur - Die besonderen Memospiele	A3.0 D81	Friedrich Jahncke GmbH & Co. KG	A3.0 D83
Die Werkstatt		JOJO e.K. Inh. Joachim Kuerz	A3.0 E25
Verlagsauslieferung GmbH	A3.0 C94	JURATOYS GmbH	A3.0 B85
Discordia Verlags GmbH	A3.0 C94	KCG Kawlath Creativ GmbH	A3.0 C66
DPH Design Agentur Dagmar Hölscher	A3.0 B49	Kleiner Norden GbR	A3.0 A48
Dr. P. Lacebo - Humormedizin		Gerd Koch Konzept & Handels GmbH	A3.0 B53
Riccarda Mueller	A3.0 B11	Winfried Kögler GmbH	A3.0 F35
ELBUFER Inh. Oliver Binikowski	A3.0 A32	kOmMa5	A3.0 E86
Verenigde Speelgoedindustrieën		Franckh-Kosmos	
Elcee-Haly B.V.	A3.0 A72	Verlags-GmbH & Co. KG	A3.0 B77
Elecosy BVBA	A3.0 E50	KRaejen GmbH	A3.0 C69
elements for kids GmbH	A3.0 B75	Kunst & Bild GmbH	A3.0 E51
Elliot GmbH	A3.0 C87	Kunst & Bild GmbH	A3.0 F20
		Die Kunstkarte	
		Inh. Andreas Nußberger	A3.0 D86

Halle A3 Hall A3

Stil & Design / Geschenke & Papeterie
Style & Design / Gifts & Stationery

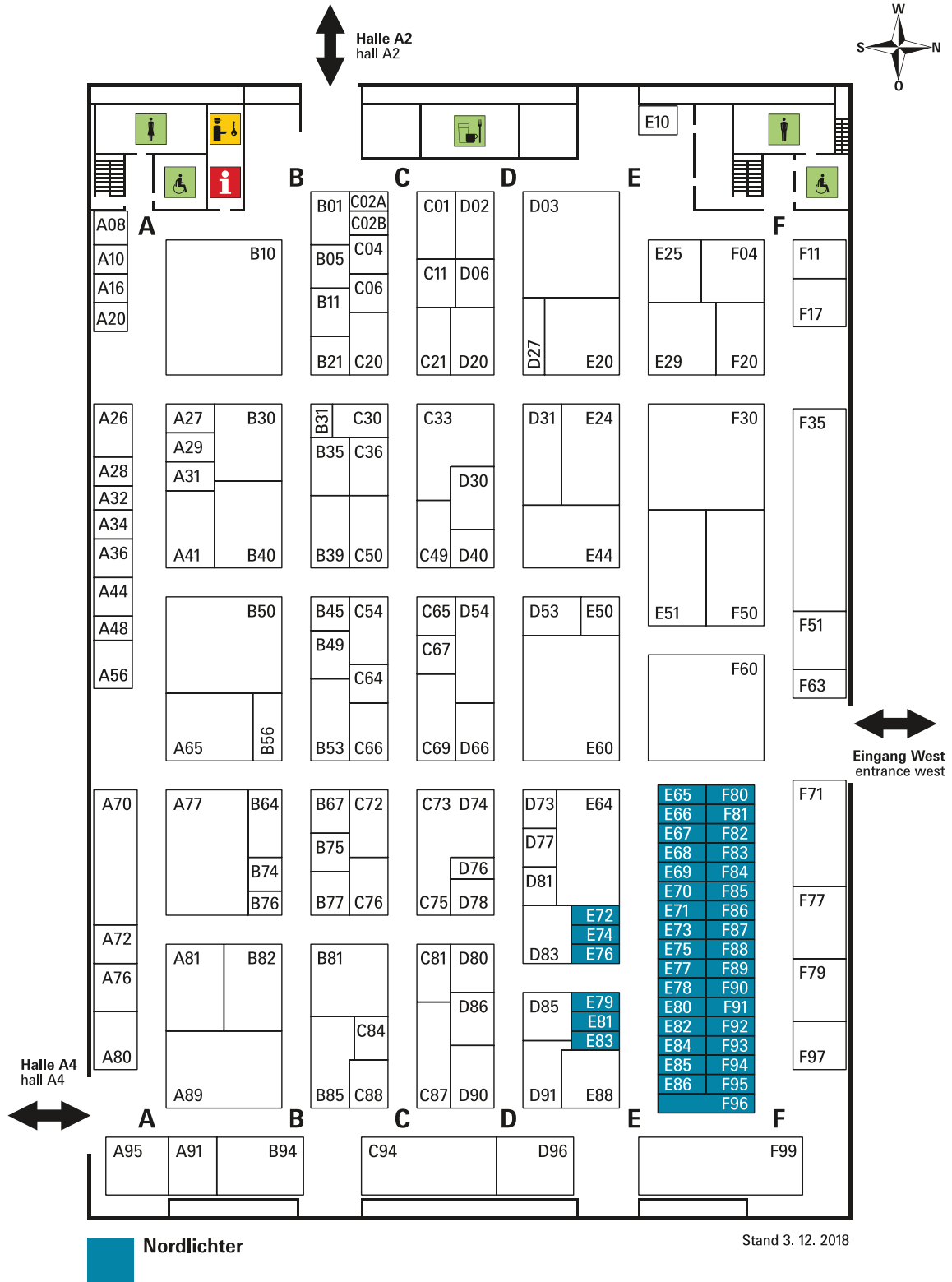

Leif GmbH	A3.0 B74	Rudolf Schaffer Collection GmbH & Co KG	A3.0 A27
Letterdistrict	A3.0 E71	Selda - Illustration & Grafik Selda Marlin Soganci	A3.0 F87
LIGARTI	A3.0 A29	Shanghai Toys (Holland)	A3.0 F11
LILALU GmbH	A3.0 D91	SHEEPWORLD AG	A3.0 E29
Lindauer Schreibgeräte & Lesehilfen, Ludwig Lipp GmbH	A3.0 A91	sigikid, H. Scharrer & Koch GmbH & Co. KG	A3.0 B81
Manufaktur Locnikar GmbH & Co. KG	A3.0 C21	Simply Flowers	A3.0 F80
LOUIS & LOUISA Handelsagentur Bornemann	A3.0 C81	Soxs.co - SEDUCI	A3.0 B01
loveS hamburg Thies & Jung GbR	A3.0 F94	Polanski Speckstein - Marco Polanski spoon.	A3.0 A26 A3.0 F88
Lütt Stina illustration & design Christiane Schmidt	A3.0 A56	Margarete Steiff GmbH	A3.0 A41
Lutz Mauder Verlag GmbH & Co. KG	A3.0 B40	Anabell Stellmacher	A3.0 F81
Magdalenen Verlag Clemens Kopp OHG	A3.0 D66	stylaz . creative studio	A3.0 E75
Masbelleza - Annika Müller	A3.0 F93	Susi Winter Design & Paper	A3.0 F91
Menk Souvenirs Inh. Matthias Röhrs	A3.0 E24	Thienemann-Esslinger Verlag GmbH	A3.0 F79
mimie & joe	A3.0 F90	TiWiSa 'Trend mit Stil'	A3.0 D80
Mindi GmbH	A3.0 E78	Toy Trade M C Biermann GmbH	A3.0 D02
Modern Times GmbH	A3.0 B30	Triple-A-Toys GmbH	A3.0 C84
MOKEY Moritz Mack	A3.0 E65	Trötsch Verlag GmbH & Co. KG	A3.0 C01
moreydesign Inhaber: Toni Morey	A3.0 A34	Trousselier S.A.S	A3.0 C88
moses. Verlag GmbH	A3.0 B82	Tushita Verlag GmbH	A3.0 C11
Mouse & Pen Illustration	A3.0 D77	Ty Germany GmbH	A3.0 A65
Münchner Verlagsgruppe GmbH	A3.0 F79	Typewine Inh. Michael Kijac	A3.0 E73
MyNewSocks.de	A3.0 C02B	Venceremos GmbH & Co. KG	A3.0 F71
Nachmacher X Inh.: Linda Langer	A3.0 B76	Peter de Vries Design	A3.0 F96
naschlabor GmbH	A3.0 E68	WäldchenVerlag Svenja Hirsch	A3.0 D76
nobis design Monica Nobis e.K.	A3.0 C65	Weathergoods AB	A3.0 E83
Nonbook & Co. Inh. Reinhard Stein	A3.0 D40	werke & formen Kerstin Selle	A3.0 B31
nuukk	A3.0 C67	Wrede Verpackungen GmbH	A3.0 D30
Out of the blue KG	A3.0 F30	Yabué Design & Grußkartenverlag, B. Bülter	A3.0 D90
P. Eisenherz Kühlborn KG	A3.0 C02A	YesBox GmbH	A3.0 D27
packart by S. Butschkat, Einzelunternehmen	A3.0 C36		
Paper Moon Grand Galleries GmbH	A3.0 B05		
Papeteria-Verlags-Unternehmergesellschaft	A3.0 D85		
Papier ahoi Reimers & Reimers GmbH	A3.0 F92		
Papierkunst Bremen	A3.0 C30		
paruspaper. nutzfeine papeterie, Heller & Camps GbR	A3.0 D53		
ROMAN PASZAK	A3.0 F17		
Pericosa - Fashion & SkinCare	A3.0 E77		
PICKMOTION	A3.0 C54		
Melanie Schwemer Plückerfinken	A3.0 A08		
PopShots Studios Ltd.	A3.0 C94		
Prisma Fachhandels AG	A3.0 E10		
ProNa GmbH & Co. KG	A3.0 F71		
RANNENBERG & FRIENDS	A3.0 E64		
Friederike Rave	A3.0 F86		
Raw Element	A3.0 A10		
ReiseLieblinge	A3.0 E69		
Relaxound GmbH	A3.0 E67		
Roadtyping - Franziska Marielle Schatz, Marius Müller	A3.0 E84		
RS Segelken GmbH	A3.0 A76		
RS Segelken GmbH	A3.0 A81		
T&K ScandicToys e.K.	A3.0 B64		

nach Standnummer

Melanie Schwemer Plückerfinken	A3.0 A08
Raw Element	A3.0 A10
G.A.W. Gaida's Angel Welt - Daniel Gaida	A3.0 A16
Roger la Borde	A3.0 A20
Polanski Speckstein - Marco Polanski	A3.0 A26
Rudolf Schaffer Collection GmbH & Co KG	A3.0 A27
Glücksschmiedin - Ulrike Alt	A3.0 A28
LIGARTI	A3.0 A29
BLOOM your message V.O.F.	A3.0 A31
ELBUFFER Inh. Oliver Binikowski	A3.0 A32
moreydesign Inhaber: Toni Morey	A3.0 A34
meer! Karin Buchholz	A3.0 A36
Margarete Steiff GmbH	A3.0 A41
Bow & Hummingbird, Inh. Carolin Hennekes	A3.0 A44
Kleiner Norden GbR	A3.0 A48
Lütt Stina illustration & design Christiane Schmidt	A3.0 A56

Halle A3 Hall A3

Stil & Design / Geschenke & Papeterie
Style & Design / Gifts & Stationery



Ty Germany GmbH	A3.0 A65	Bulla-Manufaktur für schöne Dinge	A3.0 C64
Casablanca GmbH & Co. KG		nobis design Monica Nobis e.K.	A3.0 C65
Modernes Design	A3.0 A70	KCG Kawlath Creativ GmbH	A3.0 C66
Verenigde Speelgoedindustrieën		nuukk	A3.0 C67
Elcee-Haly B.V.	A3.0 A72	KRaejen GmbH	A3.0 C69
RS Segelken GmbH	A3.0 A76	FOND OF GmbH	A3.0 C72
Casablanca GmbH & Co. KG		holzpost GmbH	A3.0 C73
Modernes Design	A3.0 A77	BUTTcamp Inh.: Ursula Fritz	A3.0 C75
Augenstolz - Michael Boock	A3.0 A80	HANSEKIND GmbH	
RS Segelken GmbH	A3.0 A81	Kindermöbel & Accessoires	A3.0 C76
Coppenrath Verlag GmbH & Co. KG	A3.0 A89	LOUIS & LOUISA	
Lindauer Schreibgeräte & Lesehilfen,		Handelsagentur Bornemann	A3.0 C81
Ludwig Lipp GmbH	A3.0 A91	Triple-A-Toys GmbH	A3.0 C84
Inware GmbH	A3.0 A95	Elliot GmbH	A3.0 C87
Soxs.co - SEDUCI	A3.0 B01	Trousselier S.A.S	A3.0 C88
Paper Moon Grand Galleries GmbH	A3.0 B05	Die Werkstatt	
Depesche Vertrieb GmbH & Co. KG	A3.0 B10	Verlagsauslieferung GmbH	A3.0 C94
Dr. P. Lacey - Humormedizin		Discordia Verlags GmbH	A3.0 C94
Riccarda Mueller	A3.0 B11	PopShots Studios Ltd.	A3.0 C94
BOHEI	A3.0 B21	Toy Trade M C Biermann GmbH	A3.0 D02
Inkognito Gesellschaft für faustdicke		HELLMANN-VERSAND GMBH	A3.0 D03
Überraschungen mbH	A3.0 B30	AXSE Axel Semblat e.K.	A3.0 D06
Modern Times GmbH	A3.0 B30	Invento Products & Services GmbH	A3.0 D20
werke & formen Kerstin Selle	A3.0 B31	YesBox GmbH	A3.0 D27
Brunnen-Verlag GmbH	A3.0 B35	Wrede Verpackungen GmbH	A3.0 D30
EPOCH Traumwiesen GmbH	A3.0 B39	Andrea Verlags GmbH	A3.0 D31
Lutz Mauder Verlag GmbH & Co. KG	A3.0 B40	Nonbook & Co. Inh. Reinhard Stein	A3.0 D40
Carry Bottles	A3.0 B45	paruspaper. nutzfeine papeterie,	
DPH Design Agentur Dagmar Hölscher	A3.0 B49	Heller & Camps GbR	A3.0 D53
AvanCarte GmbH	A3.0 B50	Cityproducts - Dr. Bianca Thierhoff	A3.0 D54
Gerd Koch Konzept & Handels GmbH	A3.0 B53	Magdalenen Verlag Clemens Kopp OHG	A3.0 D66
Crazy Three GmbH	A3.0 B56	daniels*cards	A3.0 D73
T&K ScandicToys e.K.	A3.0 B64	Art à la Card GbR	A3.0 D74
AHS-Spielzeug GmbH & Co. KG	A3.0 B67	WäldchenVerlag Svenja Hirsch	A3.0 D76
Leif GmbH	A3.0 B74	Mouse & Pen Illustration	A3.0 D77
elements for kids GmbH	A3.0 B75	Fantasie4Kids OHG	A3.0 D78
Nachmacher X Inh.: Linda Langer	A3.0 B76	TiWiSa 'Trend mit Stil'	A3.0 D80
Franckh-Kosmos		die memofaktur -	
Verlags-GmbH & Co. KG	A3.0 B77	Die besonderen Memospiele	A3.0 D81
sigikid, H. Scharrer & Koch		Friedrich Jahncke GmbH & Co. KG	A3.0 D83
GmbH & Co. KG	A3.0 B81	Papeteria-Verlags-	
moses. Verlag GmbH	A3.0 B82	Unternehmergeellschaft	A3.0 D85
JURATOYS GmbH	A3.0 B85	Die Kunstkarte	
HABA - Habermaass GmbH	A3.0 B94	Inh. Andreas Nußberger	A3.0 D86
Trötsch Verlag GmbH & Co. KG	A3.0 C01	Yabué Design & Grußkartenverlag,	
P. Eisenherz Kühlborn KG	A3.0 C02A	B. Bültner	A3.0 D90
MyNewSocks.de	A3.0 C02B	LILALU GmbH	A3.0 D91
ETISYS Etikettierlösungen GmbH	A3.0 C04	Gebrüder Bertels	
HERMA GmbH	A3.0 C06	Handelsvertretungen GmbH	A3.0 D96
Tushita Verlag GmbH	A3.0 C11	Braun + Company Papierwaren GmbH	A3.0 D96
Fun Unlimited Products GmbH	A3.0 C20	Prisma Fachhandels AG	A3.0 E10
Manufaktur Locnikar GmbH & Co. KG	A3.0 C21	Hartung GmbH & Co. KG	A3.0 E20
Papierkunst Bremen	A3.0 C30	Menk Souvenirs Inh. Matthias Röhrs	A3.0 E24
bb Klostermann GmbH	A3.0 C33	JOJO e.K. Inh. Joachim Kuerz	A3.0 E25
packart by S. Butschkat,		SHEEPWORLD AG	A3.0 E29
Einzelunternehmen	A3.0 C36	Grätz Verlag GmbH	A3.0 E44
inhoma	A3.0 C49	Elecosy BVBA	A3.0 E50
H.C.A. Collection Handels-GmbH	A3.0 C50	Goldbuch Georg Brückner GmbH	A3.0 E51
PICKMOTION	A3.0 C54	Kunst & Bild GmbH	A3.0 E51

Halle A3 Hall A3

Stil & Design / Geschenke & Papeterie
Style & Design / Gifts & Stationery



Becker & Becker Vertrieb GmbH & Co. KG Grafik Werkstatt	A3.0 E60	mimie & joe	A3.0 F90
RANNENBERG & FRIENDS	A3.0 E64	Susi Winter Design & Paper	A3.0 F91
MOKEY Moritz Mack	A3.0 E65	Papier ahoi Reimers & Reimers GmbH	A3.0 F92
ever&again Inh. Kristina Günther	A3.0 E66	Masbelleza - Annika Müller	A3.0 F93
Relaxound GmbH	A3.0 E67	loveS hamburg Thies & Jung GbR	A3.0 F94
naschlabor GmbH	A3.0 E68	DANKEBOX	A3.0 F95
ReiseLieblinge	A3.0 E69	Peter de Vries Design	A3.0 F96
Birgit Bertz - WILD at Art Design	A3.0 E70	GAPYRUS OHG G. Biegert / A. Lohmann-Biegert Buchbinderarbeiten	A3.0 F97
Letterdistrict	A3.0 E71	HobbyFun GmbH & Co. KG	A3.0 F99
Collema Wrapping	A3.0 E72		
Typewine Inh. Michael Kijac	A3.0 E73		
Hammar Posse	A3.0 E74		
stylaz . creative studio	A3.0 E75		
hjärtslag home textiles	A3.0 E76		
Pericosa - Fashion & SkinCare	A3.0 E77		
Mindi GmbH	A3.0 E78		
BCM concept + marketing GmbH	A3.0 E79		
Interior Kunst und Einrichtung Inhaber Monica Dadder	A3.0 E80		
Hjemhavn	A3.0 E81		
beeGoodies-hellogreen GbR	A3.0 E82		
Weathergoods AB	A3.0 E83		
Roadtyping - Franziska Marielle Schatz, Marius Müller	A3.0 E84		
dearsoap Inh. Sylvia Woelki	A3.0 E85		
kOmMa5	A3.0 E86		
Creativ Company Deutschland GmbH	A3.0 E88		
Klaus Hanfstingl Verlag GmbH	A3.0 F04		
Shanghai Toys (Holland)	A3.0 F11		
ROMAN PASZAK	A3.0 F17		
FantasTick Greetings GmbH	A3.0 F20		
Kunst & Bild GmbH	A3.0 F20		
Out of the blue KG	A3.0 F30		
Winfried Kögler GmbH	A3.0 F35		
Berk Esoterik e.K.	A3.0 F50		
Indian Lotus Pvt. Ltd.	A3.0 F51		
Cepewa GmbH	A3.0 F60		
Happy Accessories AB	A3.0 F63		
ProNa GmbH & Co. KG	A3.0 F71		
Venceremos GmbH & Co. KG	A3.0 F71		
Acte tre Deutschland GmbH	A3.0 F77		
arsEdition GmbH	A3.0 F79		
CARLSEN Verlag GmbH	A3.0 F79		
Münchner Verlagsgruppe GmbH	A3.0 F79		
Thienemann-Esslinger Verlag GmbH	A3.0 F79		
Simply Flowers	A3.0 F80		
Anabell Stellmacher	A3.0 F81		
Designkonsorten GbR	A3.0 F82		
Feingeladen	A3.0 F83		
FOX & POET Fuchs & Zips GbR	A3.0 F84		
Frau Schnobel Grafik Inh. Martina Olonschek	A3.0 F85		
Friederike Rave	A3.0 F86		
Selda - Illustration & Grafik Selda Marlin Soganci	A3.0 F87		
spoon.	A3.0 F88		
Hey!Cards GmbH & Co. KG	A3.0 F89		

Halle A4 Hall A4

Stil & Design
Style & Design

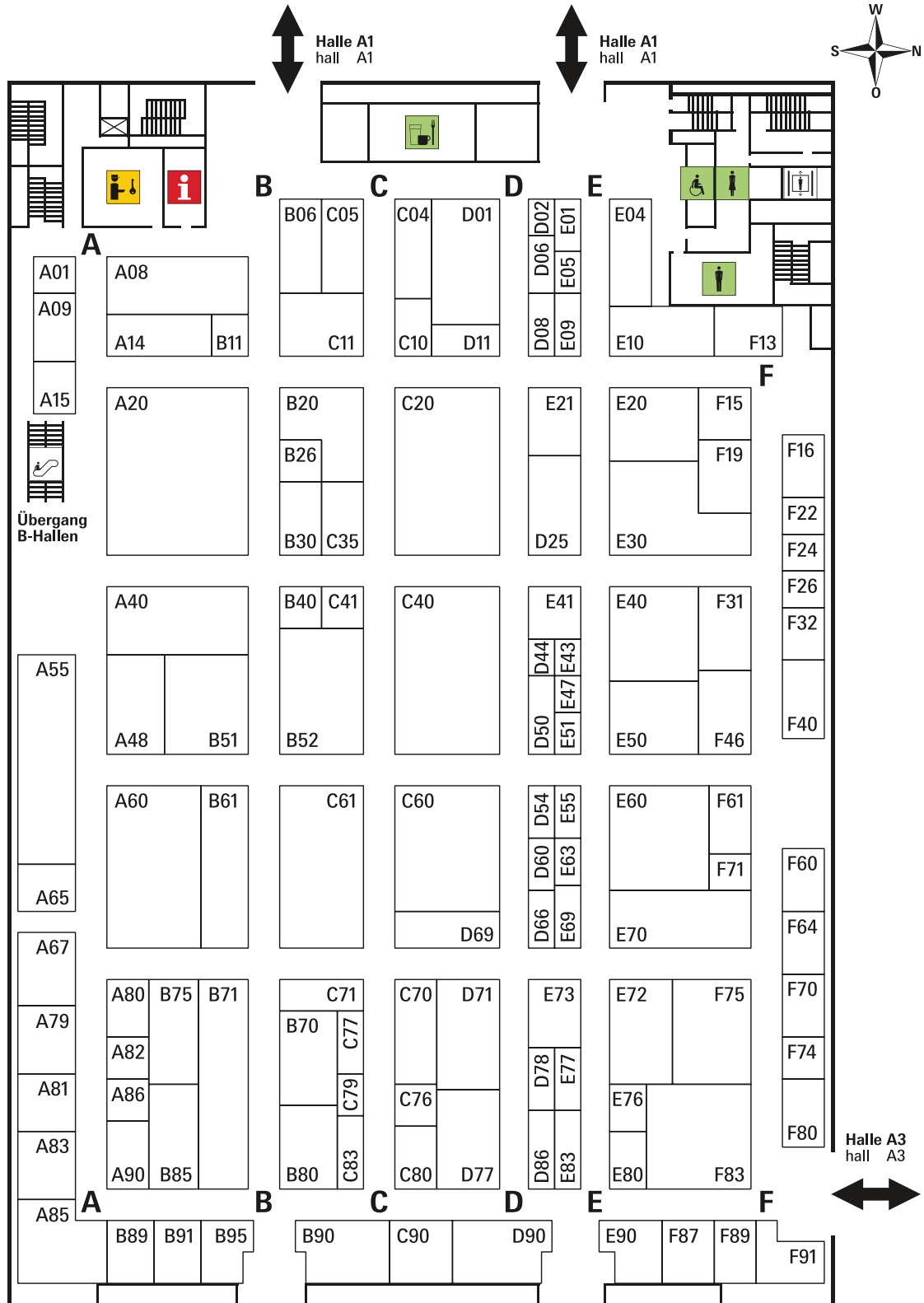

Stand 3. 12. 2018

alphabetisch

17;30 - Agentur Anna Upleger GmbH & Co. KG	A4.0 E20	Greenbomb	A4.0 F87
Acufactum Ute Menze	A4.0 E90	Grete & Lore, Anne Kathrin Köpke e.K.	A4.0 F26
AdHoc Entwicklung und Vertrieb GmbH	A4.0 A79	größer fatter breiter Inh. Jan Sprengel	A4.0 B89
ANOTHER ME Uniqueness Lifestyle (haftungsbeschränkt)	A4.0 D69	HANDED BY BV	A4.0 A14
Antikapratika Ceramics	A4.0 D08	Handelskompagniet - Henrik Steen A/S	A4.0 A08
ARTEBENE GmbH	A4.0 D71	HEYHOME – Kai Berger	A4.0 E80
Aspegren DesignDK Free Form ApS	A4.0 E21	HOCK Design e.K. Kristof Hock	A4.0 D78
AU MAISON A/S	A4.0 E40	IB Laursen	A4.0 A20
ava & yves GmbH	A4.0 D25	Indra Ohlemutz IOPLA	A4.0 E69
Bahne & Co.	A4.0 E70	Joouls / IHAK	
BATELA 1991 S.L.	A4.0 A55	Internationale Im- und Export Handelsgesellschaft mbH & Co. KG	A4.0 A81
BEAD GmbH	A4.0 C35	PM ModeAgentur Petra Jost-Drai	A4.0 C79
besonderk Handelsagentur Inh.: Annamaria Kranzer	A4.0 A09	Kikkerland Europe B.V.	A4.0 C70
blomus GmbH	A4.0 C60	Kila-Photography Deine Stadt auf Holz	A4.0 E51
Blossify.com / Huiskamergeluk V.O.F.	A4.0 C11	Kleen-TEX Industries GmbH	A4.0 F80
Susanne Boerner		Klein & More (Klein AG)	A4.0 A83
GuteMiene/art-work/metal-work/edition	A4.0 A40	KLINTA Deutschland	A4.0 D44
BULL&HUNT zip&friends GmbH & Co. KG	A4.0 E41	Knit Factory	A4.0 F19
THE BUTTIQUE	A4.0 F46	krima & isa GmbH	A4.0 B90
Care by Me ApS	A4.0 A09	Kuhn Rikon AG	A4.0 F80
Carmen Fischer Agents Vertriebsagentur e.K.	A4.0 D69	Kylskapspoesi AB	A4.0 C90
cats on appletrees Gebert / Heidner / Heidrich GbR	A4.0 E04	Lanco Ducks	A4.0 D86
CEDON MuseumShops GmbH	A4.0 A48	Liebeskummerpillen GmbH	A4.0 D66
CHI CHI FAN Hamburg	A4.0 B30	LIEBlingsSTÜCKE® by martina wodke	A4.0 F15
chic.mic GmbH	A4.0 F75	liix Inh. Marcel Jansen	A4.0 F16
COKOE - Cornelia Köhler	A4.0 D02	Living by Colors	A4.0 D11
Cup+Mug Company GmbH	A4.0 F60	Luca Kayz by perfect belt GmbH	A4.0 C04
D&C SAS	A4.0 F91	Madam Stoltz ApS	A4.0 F83
dekoop GmbH	A4.0 C83	MAGS Vertriebs GmbH	A4.0 E72
Fourman & Co. GmbH, Designmanufaktur Berlin	A4.0 C41	Maileg ApS	A4.0 E10
DieStadtgärtner Inh. Derk Niemeijer	A4.0 C80	Many Mornings Deutschland	A4.0 C10
Doiycustom S.L.	A4.0 F70	Mark's Europe SARL	A4.0 B20
Donkey Products GmbH & Co. KG	A4.0 B75	Matcha Paris	A4.0 E43
dorothee lehnen GmbH	A4.0 B06	Jurianne Matter	A4.0 A09
Agentur DoubleDutch	A4.0 F24	Horst Meier + Stefan Koch	
DutZ collection by Nethroma BV	A4.0 E60	Spiel- und Designobjekte Modellentwicklung GbR	A4.0 B40
eDITION GUTE GEISTER	A4.0 D06	MeterMorphosen GmbH	A4.0 A15
En Gry & Sif ApS	A4.0 E76	Kristin und Matthias Meyerhoff GbR	A4.0 F71
Eulenschnitt	A4.0 E73	Walter Michaelsen e.K.	A4.0 A65
Peter Ewert Handelsagentur	A4.0 E50	Mintkind GmbH & Co.KG	A4.0 C77
F & H A/S	A4.0 E30	Mossapour Interior Designs OHG	A4.0 D01
FIFTYEIGHT 3D GmbH	A4.0 A80	Nedelmann	A4.0 C05
formes Berlin GbR	A4.0 F46	Ninelives Inh. Helena Rahikainen	A4.0 E47
Frohstoff Meike Marie Buchholz	A4.0 B95	NOGALLERY -	
Funky Doris AS	A4.0 A09	Rosenkranz & Burgmann GbR	A4.0 B85
Gift Company Geschenke Vertriebs GmbH	A4.0 C61	Noi Hamburg Scherer Voigt GbR	A4.0 D90
Good old friends GmbH	A4.0 B51	Nordal A/S	A4.0 C20
Good old friends GmbH	A4.0 B61	not the girl who misses much oHG	A4.0 E09
Good old friends GmbH	A4.0 B71	The Oak Men ApS	A4.0 A09
		Pad home design concept GmbH	A4.0 C40
		Paperproducts Design GmbH	A4.0 B80
		papoutsi !	A4.0 A86
		Paprcuts, Nils Wagner	A4.0 B91
		Pechkeks GmbH	A4.0 A67
		PHILIPPI	A4.0 B70
		Thomas Poganitsch	A4.0 E05

Halle A4 Hall A4

Stil & Design
Style & Design

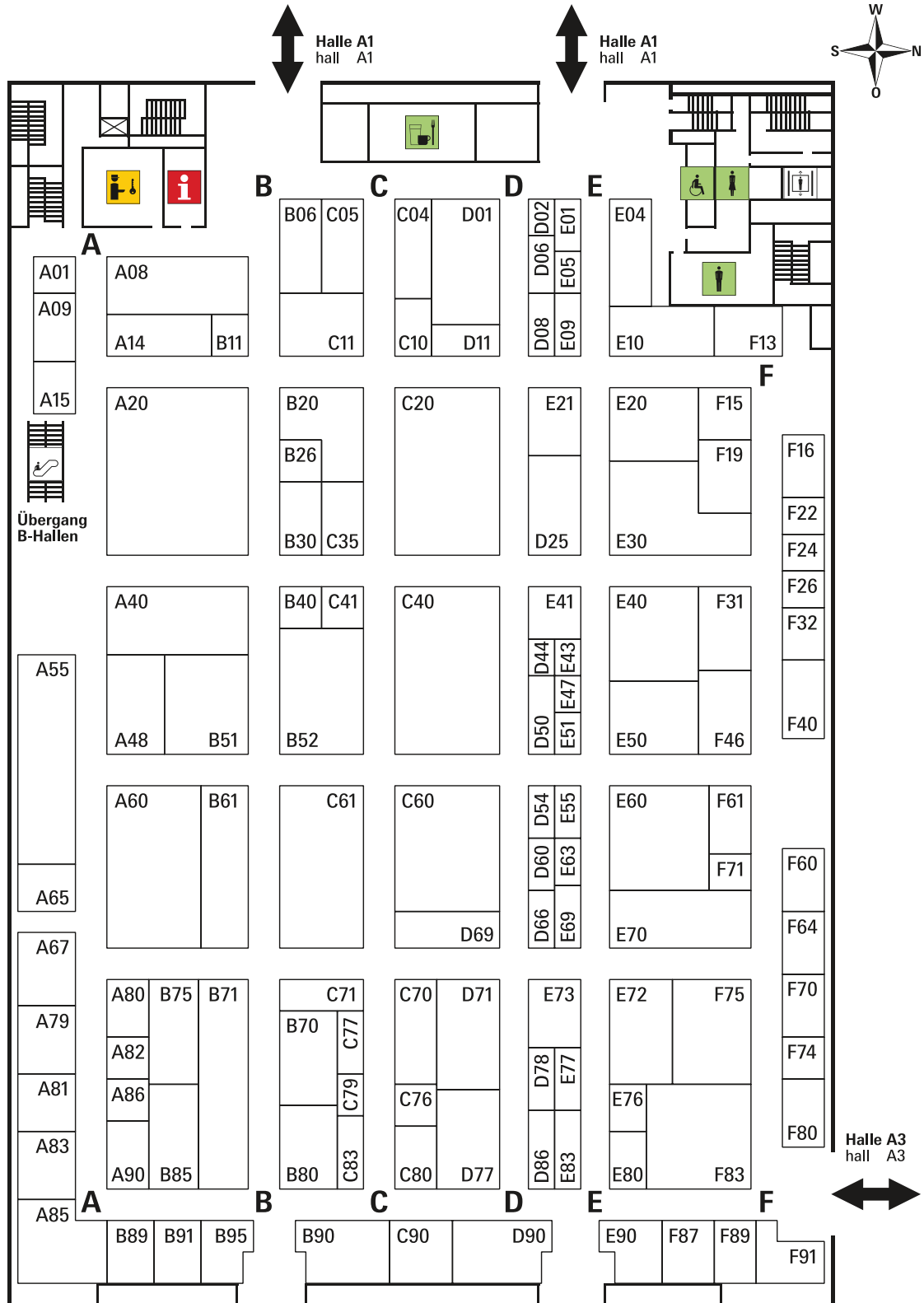

Stand 3. 12. 2018

Powder Design Ltd	A4.0 F74	AdHoc Entwicklung und Vertrieb GmbH	A4.0 A79
Puffs Brause UG (haftungsbeschränkt)	A4.0 D69	FIFTYEIGHT 3D GmbH	A4.0 A80
Räder GmbH	A4.0 A60	Jouuls / IHAK	
Rasmussons papergoods & gifts		Internationale Im- und Export Handelsgesellschaft mbH & Co. KG	A4.0 A81
Danny Rasmusson	A4.0 E63	Sophieplus Inh. Sarah Kinard	A4.0 A82
Raumgestalt GmbH	A4.0 C71	Klein & More (Klein AG)	A4.0 A83
Reisenthal Accessoires GmbH & Co. KG	A4.0 B52	papouts! !	A4.0 A86
Risvig Design ApS	A4.0 A01	Xanadoo Gifts and Presents GmbH	A4.0 A90
Salon Elfi - Verena Schätzlein	A4.0 E55	dorothee lehen GmbH	A4.0 B06
SANTOKKI Inh. Kyung-Wyon Lee	A4.0 E01	Spruchketten by Lieblichkeiten GmbH	A4.0 B11
SCHICKESDING - Inhaber Anika Schickerling	A4.0 D60	Mark's Europe SARL	A4.0 B20
Eva Schreiber GmbH & Co. KG	A4.0 C05	Wissenbach Handelsgesellschaft mbH	A4.0 B26
Seemannslicht GbR	A4.0 D60	CHI CHI FAN Hamburg	A4.0 B30
Sophieplus Inh. Sarah Kinard	A4.0 A82	Horst Meier + Stefan Koch	
Spruchketten by Lieblichkeiten GmbH	A4.0 B11	Spiel- und Designobjekte	
Stoffbox:Hamburg Ismail Tut	A4.0 F32	Modellentwicklung GbR	A4.0 B40
Taschenagentur Kramer e.U.	A4.0 E83	Good old friends GmbH	A4.0 B51
tinéba Inhaber: Christine Bath	A4.0 D54	Reisenthal Accessoires GmbH & Co. KG	A4.0 B52
to stock GmbH	A4.0 F22	Good old friends GmbH	A4.0 B61
TRANQUILLO GmbH	A4.0 D77	PHILIPPI	A4.0 B70
Tudi Billo OHG	A4.0 F64	Good old friends GmbH	A4.0 B71
USE, Union Sozialer Einrichtungen gemeinnützige GmbH	A4.0 C76	Donkey Products GmbH & Co. KG	A4.0 B75
VENTO Vertriebs GmbH	A4.0 F31	Paperproducts Design GmbH	A4.0 B80
ViSSEVASSE ApS	A4.0 F13	NOGALLERY -	
vonHollstein. Thomas Hollstein	A4.0 E77	Rosenkranz & Burgmann GbR	A4.0 B85
Wildlife Garden AB	A4.0 F61	größer fetter breiter Inh. Jan Sprengel	A4.0 B89
Wissenbach Handelsgesellschaft mbH	A4.0 B26	krima & isa GmbH	A4.0 B90
woodcardz UG (haftungsbeschränkt)	A4.0 D50	Paprcuts, Nils Wagner	A4.0 B91
Xanadoo Gifts and Presents GmbH	A4.0 A90	Frohstoff Meike Marie Buchholz	A4.0 B95
Trendagentur Sven Zabel	A4.0 F40	Luca Kayz by perfect belt GmbH	A4.0 C04
Zielonka Wohnen & Leben GmbH	A4.0 F80	Nedelmann	A4.0 C05
MZ Vertriebsagentur CDH		Eva Schreiber GmbH & Co. KG	A4.0 C05
Manfred Zilleßen	A4.0 F80	Many Mornings Deutschland	A4.0 C10
		Blossify.com / Huiskamergeluk V.O.F.	A4.0 C11
		Nordal A/S	A4.0 C20
		BEAD GmbH	A4.0 C35
		Pad home design concept GmbH	A4.0 C40
		Fourman & Co. GmbH,	
		Designmanufaktur Berlin	A4.0 C41
		blomus GmbH	A4.0 C60
		Gift Company Geschenke	
		Vertriebs GmbH	A4.0 C61
		Kikkerland Europe B.V.	A4.0 C70
		Raumgestalt GmbH	A4.0 C71
		USE, Union Sozialer Einrichtungen	
		gemeinnützige GmbH	A4.0 C76
		Mintkind GmbH & Co.KG	A4.0 C77
		PM ModeAgentur Petra Jost-Drai	A4.0 C79
		DieStadtgärtner Inh. Derk Niemeijer	A4.0 C80
		dekoop GmbH	A4.0 C83
		Kylskapspoesi AB	A4.0 C90
		Mossapour Interior Designs OHG	A4.0 D01
		COKOE - Cornelia Köhler	A4.0 D02
		eDITION GUTE GEISTER	A4.0 D06
		Antikapratika Ceramics	A4.0 D08
		Living by Colors	A4.0 D11
		ava & yves GmbH	A4.0 D25

nach Standnummer

Risvig Design ApS	A4.0 A01
Handelskompagniet - Henrik Steen A/S	A4.0 A08
besonderk Handelsagentur	
Inh.: Annamaria Kranzer	A4.0 A09
Care by Me ApS	A4.0 A09
Funky Doris AS	A4.0 A09
Jurianne Matter	A4.0 A09
The Oak Men ApS	A4.0 A09
HANDED BY BV	A4.0 A14
MeterMorphosen GmbH	A4.0 A15
IB Laursen	A4.0 A20
Susanne Boerner	
GuteMiene/art-work/metal-work/edition	A4.0 A40
CEDON MuseumShops GmbH	A4.0 A48
BATELA 1991 S.L.	A4.0 A55
Räder GmbH	A4.0 A60
Walter Michaelsen e.K.	A4.0 A65
Pechkeks GmbH	A4.0 A67

Halle A4 Hall A4

Stil & Design
Style & Design

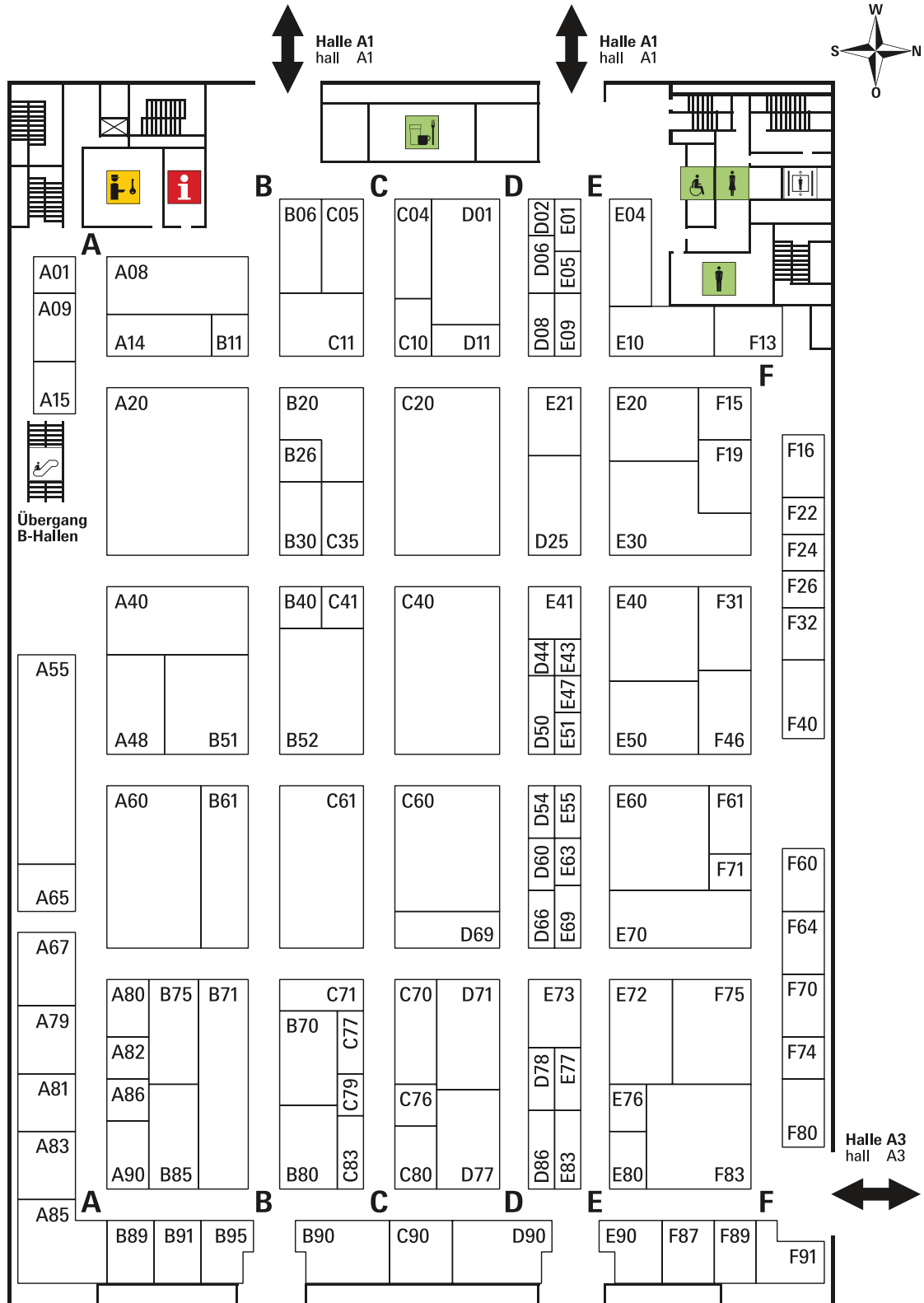

Stand 3. 12. 2018

KLINTA Deutschland	A4.0 D44	Cup+Mug Company GmbH	A4.0 F60
woodcardz UG (haftungsbeschränkt)	A4.0 D50	Wildlife Garden AB	A4.0 F61
tinéba Inhaber: Christine Bath	A4.0 D54	Tudi Billo OHG	A4.0 F64
SCHICKESSDING - Inhaber Anika Schickerling	A4.0 D60	Doiycustom S.L.	A4.0 F70
Seemannslicht GbR	A4.0 D60	Kristin und Matthias Meyerhoff GbR	A4.0 F71
Liebeskummerpillen GmbH	A4.0 D66	Powder Design Ltd	A4.0 F74
ANOTHER ME Uniqueness Lifestyle (haftungsbeschränkt)	A4.0 D69	chic.mic GmbH	A4.0 F75
Carmen Fischer Agents Vertriebsagentur e.K.	A4.0 D69	Kleen-TEX Industries GmbH	A4.0 F80
Puffs Brause UG (haftungsbeschränkt)	A4.0 D69	Kuhn Rikon AG	A4.0 F80
ARTEBENE GmbH	A4.0 D71	Zielonka Wohnen & Leben GmbH	A4.0 F80
TRANQUILLO GmbH	A4.0 D77	MZ Vertriebsagentur CDH	A4.0 F80
HOCK Design e.K. Kristof Hock	A4.0 D78	Manfred Zilleßen	A4.0 F80
Lanco Ducks	A4.0 D86	Madam Stoltz ApS	A4.0 F83
Noi Hamburg Scherer Voigt GbR	A4.0 D90	Greenbomb	A4.0 F87
SANTOKKI Inh. Kyung-Wyon Lee	A4.0 E01	D&C SAS	A4.0 F91
cats on appletrees Gebert / Heidner / Heidrich GbR	A4.0 E04		
Thomas Poganitsch	A4.0 E05		
not the girl who misses much oHG	A4.0 E09		
Maileg ApS	A4.0 E10		
17;30 - Agentur Anna Upleger GmbH & Co. KG	A4.0 E20		
Aspegren DesignDK Free Form ApS	A4.0 E21		
F & H A/S	A4.0 E30		
AU MAISON A/S	A4.0 E40		
BULL&HUNT zip&friends GmbH & Co. KG	A4.0 E41		
Matcha Paris	A4.0 E43		
Ninelives Inh. Helena Rahikainen	A4.0 E47		
Peter Ewert Handelsagentur	A4.0 E50		
Kila-Photography Deine Stadt auf Holz	A4.0 E51		
Salon Elfi - Verena Schätzlein	A4.0 E55		
DutZ collection by Nethroma BV	A4.0 E60		
Rasmussons papergoods & gifts Danny Rasmusson	A4.0 E63		
Indra Ohlemutz IOPLA	A4.0 E69		
Bahne & Co.	A4.0 E70		
MAGS Vertriebs GmbH	A4.0 E72		
Eulenschnitt	A4.0 E73		
En Gry & Sif ApS	A4.0 E76		
vonHollstein. Thomas Hollstein	A4.0 E77		
HEYHOME – Kai Berger	A4.0 E80		
Taschenagentur Kramer e.U.	A4.0 E83		
Acufactum Ute Menze	A4.0 E90		
ViSSEVASSE ApS	A4.0 F13		
LIEBlingsSTÜCKE® by martina wodke	A4.0 F15		
liix Inh. Marcel Jansen	A4.0 F16		
Knit Factory	A4.0 F19		
to stock GmbH	A4.0 F22		
Agentur DoubleDutch	A4.0 F24		
Grete & Lore, Anne Kathrin Köpke e.K.	A4.0 F26		
VENTO Vertriebs GmbH	A4.0 F31		
Stoffbox:Hamburg Ismail Tut	A4.0 F32		
Trendagentur Sven Zabel	A4.0 F40		
THE BUTTIQUE	A4.0 F46		
formes Berlin GbR	A4.0 F46		

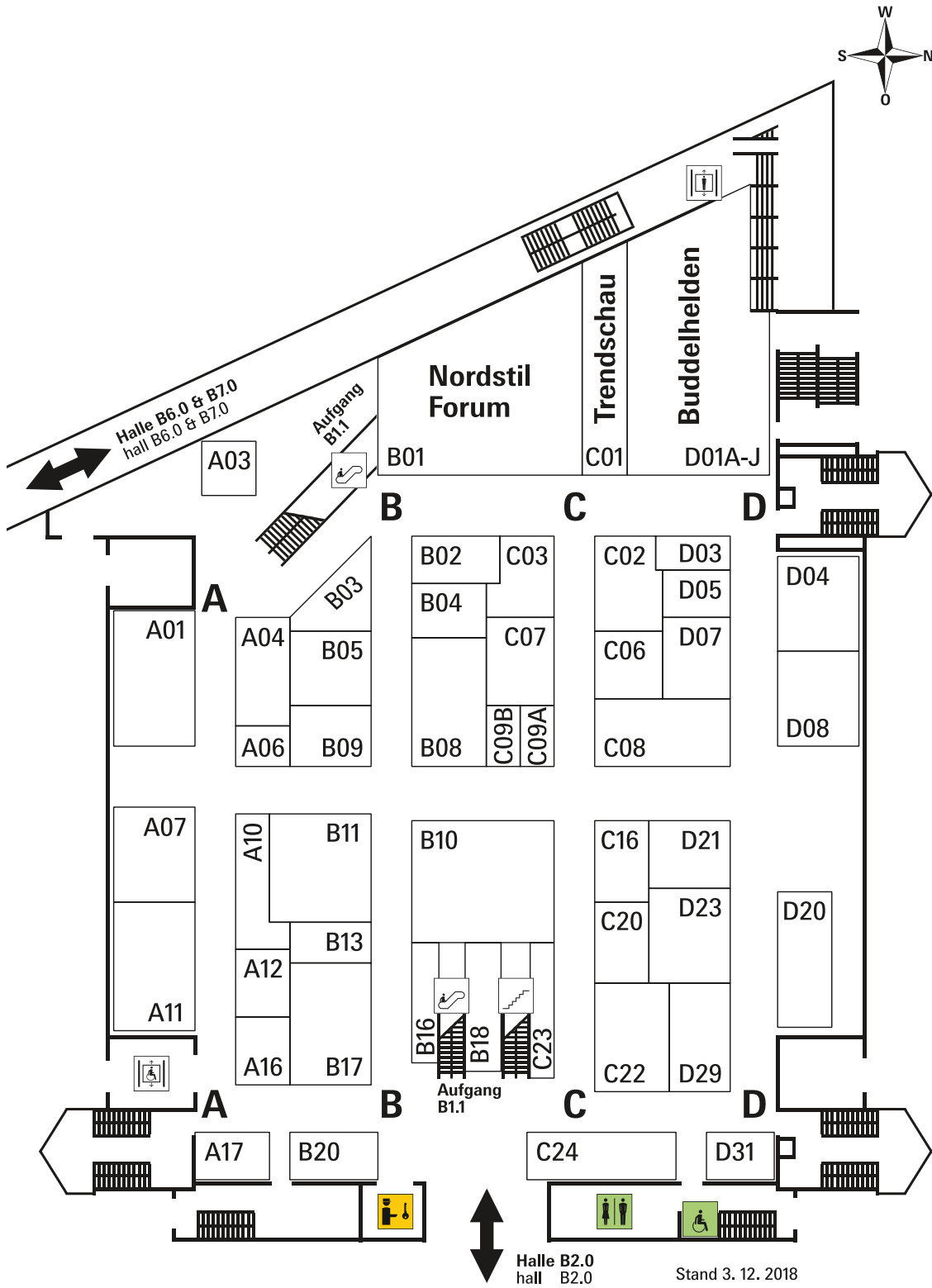

alphabetisch

0815 Extrem Gut AHA Factory, Axel Hadulla	B1.0 A10	Patrizia GmbH	B1.0 D20
Action Sports GmbH	B1.0 A17	pHenomenal DRINKS / Inh. Hendrik Schaulin	B1.0 A10
Ahland Handelsagentur oHG	B1.0 C24	Pi Tea GmbH	B1.0 A03
Amodeo Food GmbH	B1.0 B20	Puffs Brause UG (haftungsbeschränkt)	B1.0 A10
Knut Hansen Gin (4anchors OHG)	B1.0 D01B	Red Summer Andreas Klein	
Andersson Import GmbH	B1.0 C06	Fruchtverarbeitung	B1.0 D01I
Aroma Olymp, Alexander Cowell	B1.0 A10	rosen feines	B1.0 A04
avita Handels GmbH	B1.0 B04	Sauerland Distillers GmbH	B1.0 D01L
Biller Naturmittel	B1.0 A07	Die Schlemmerei e.K.	B1.0 C09B
Brainstream GmbH	B1.0 B09	Schusters Spezialitäten GbR	B1.0 C23
Bredemeijer Group B.V.	B1.0 C20	Schwechower Obstbrennerei Inh. Frank Jehring e.K.	B1.0 D01C
Buah GmbH	B1.0 A10	Sel la vie - Moritz Lübbers	B1.0 D03
Bubenstolz Deutschland GmbH	B1.0 D01J	Ship it GmbH	B1.0 D01A
CMF-Produkte Keller	B1.0 B02	Svenja S. Collection	B1.0 C03
Confiserie Paulsen Manufaktur - Biebl Handelsges. mbH	B1.0 A04	Tassenmann GmbH	B1.0 B05
Daja Chocolate		Tea Goetz GmbH	B1.0 B03
Schokoladenmanufaktur KG	B1.0 B16	Timbercoast GmbH	B1.0 D01G
Wurst & Schinkenmanufaktur Deckena GmbH	B1.0 D04	Tomatenschmatz und Co. Karin Paetow	B1.0 A04
Delicatissimo	B1.0 D01E	Urban Craft GmbH	B1.0 D01K
Deligreece GmbH	B1.0 B17	Veedel Distillers UG	B1.0 D01D
Delikatessenwinkel GbR	B1.0 B11	Wein & Secco Köth GmbH	B1.0 D31
Dethlefsen & Balk Tee & Kaffee GmbH	B1.0 A01	Witzgall GmbH & Co. KG	B1.0 B08
Feuer & Glas OHG	B1.0 C22	Zuco	B1.0 A12
Florapharm			
Pflanzliche Naturprodukte GmbH	B1.0 D08		
Ginsanity / Frangenberg & Frangenberg GbR	B1.0 D01H		
Gmeiner Confiserie & Kaffeehausunternehmen	B1.0 C16		
GoldCorn GmbH	B1.0 A04		
Gourmet Berner GmbH & Co. KG	B1.0 B10		
Gourmet Berner GmbH & Co. KG	B1.0 B18		
Greenomic Delikatessen	B1.0 C08		
H&B Handelskontor GmbH / HEINE Delikatessen GmbH & Co. KG	B1.0 A11		
Hanse Tee Contor Wismar GmbH	B1.0 D21		
Havelwasser - Rafael Kugel	B1.0 A04		
IMV Spezialitäten-Import, Marketing & Vertriebs GmbH	B1.0 C07		
ja-unendlich GbR			
Allan und Jeannette Belter	B1.0 A06		
Kramer's Spezialitäten GmbH	B1.0 D23		
Kunst & Kultur, Gläser von LA ROCHERE, Bernd-Michael Müller	B1.0 D05		
Lang Weinessig Event GmbH	B1.0 A16		
Lanwehr GmbH, Confiserie - Manufaktur	B1.0 D07		
Market Grounds GmbH & Co. KG	B1.0 D29		
Maximilian Markus Hörmann	B1.0 B13		
Merkle & Biskup OHG	B1.0 C02		
my-own-coffee Kaffee-manufaktur Ingrid Grau	B1.0 C09A		
Nusswerk GmbH	B1.0 A04		
O'Donnell Moonshine GmbH	B1.0 A10		
4orange UG (haftungsbeschränkt)	B1.0 D01F		

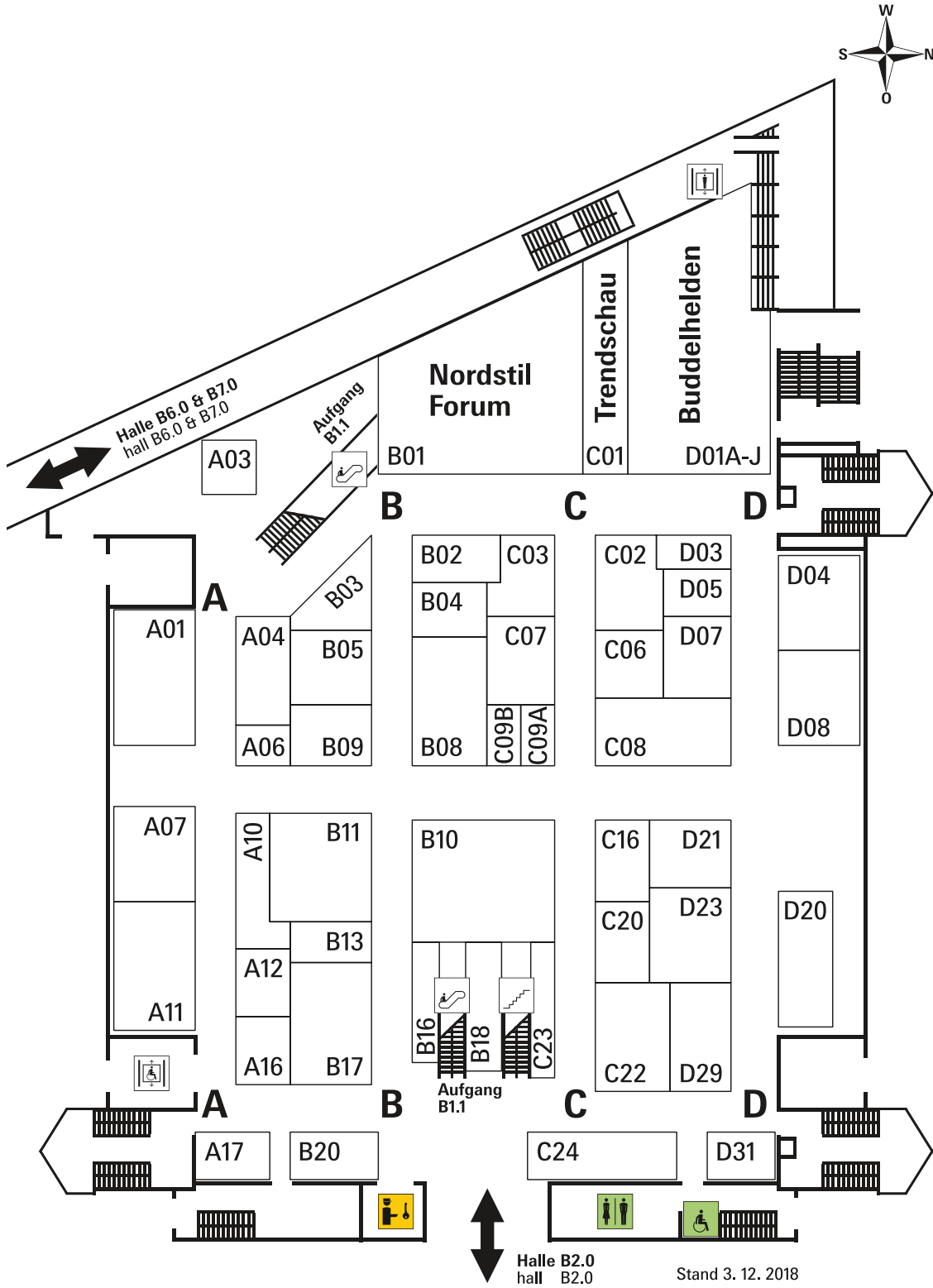

nach Standnummer

Dethlefsen & Balk Tee & Kaffee GmbH	B1.0 A01	Schwechower Obstbrennerei Inh. Frank Jehring e.K.	B1.0 D01C
Pi Tea GmbH	B1.0 A03	Veedel Distillers UG	B1.0 D01D
Confiserie Paulsen Manufaktur - Biebl Handelsges. mbH	B1.0 A04	Delicatissimo	B1.0 D01E
GoldCorn GmbH	B1.0 A04	4orange UG (haftungsbeschränkt)	B1.0 D01F
Havelwasser - Rafael Kugel	B1.0 A04	Timbercoast GmbH	B1.0 D01G
Nusswerk GmbH	B1.0 A04	Ginsanity / Frangenberg & Frangenberg GbR	B1.0 D01H
rosen feines	B1.0 A04	Red Summer Andreas Klein Fruchtverarbeitung	B1.0 D01I
Tomatenschmatz und Co. Karin Paetow	B1.0 A04	Bubenstolz Deutschland GmbH	B1.0 D01J
ja-unendlich GbR		Urban Craft GmbH	B1.0 D01K
Allan und Jeannette Belter	B1.0 A06	Sauerland Distillers GmbH	B1.0 D01L
Biller Naturmittel	B1.0 A07	Sel la vie - Moritz Lübbers	B1.0 D03
0815 Extrem Gut AHA Factory, Axel Hadulla	B1.0 A10	Wurst & Schinkenmanufaktur Deckena GmbH	B1.0 D04
Aroma Olymp, Alexander Cowell	B1.0 A10	Kunst & Kultur, Gläser von LA ROCHERE, Bernd-Michael Müller	B1.0 D05
Buah GmbH	B1.0 A10	Lanwehr GmbH, Confiserie - Manufaktur	B1.0 D07
O'Donnell Moonshine GmbH	B1.0 A10	Florapharm	
pHenomenal DRINKS / Inh. Hendrik Schaulin	B1.0 A10	Pflanzliche Naturprodukte GmbH	B1.0 D08
Puffs Brause UG (haftungsbeschränkt)	B1.0 A10	Patrizia GmbH	B1.0 D20
H&B Handelskontor GmbH / HEINE Delikatessen GmbH & Co. KG	B1.0 A11	Hanse Tee Contor Wismar GmbH	B1.0 D21
Zuco	B1.0 A12	Kramer's Spezialitäten GmbH	B1.0 D23
Lang Weinessig Event GmbH	B1.0 A16	Market Grounds GmbH & Co. KG	B1.0 D29
Action Sports GmbH	B1.0 A17	Wein & Secco Köth GmbH	B1.0 D31
CMF-Produkte Keller	B1.0 B02		
Tea Goetz GmbH	B1.0 B03		
avita Handels GmbH	B1.0 B04		
Tassenmann GmbH	B1.0 B05		
Witzgall GmbH & Co. KG	B1.0 B08		
Brainstream GmbH	B1.0 B09		
Gourmet Berner GmbH & Co. KG	B1.0 B10		
Delikatessenwinkel GbR	B1.0 B11		
Maximilian Markus Hörmann	B1.0 B13		
Daja Chocolate Schokoladenmanufaktur KG	B1.0 B16		
Deligreece GmbH	B1.0 B17		
Gourmet Berner GmbH & Co. KG	B1.0 B18		
Amodeo Food GmbH	B1.0 B20		
Merkle & Biskup OHG	B1.0 C02		
Svenja S. Collection	B1.0 C03		
Andersson Import GmbH	B1.0 C06		
IMV Spezialitäten-Import, Marketing & Vertriebs GmbH	B1.0 C07		
Greenomic Delikatessen	B1.0 C08		
my-own-coffee Kaffeemanufaktur Ingrid Grau	B1.0 C09A		
Die Schlemmerei e.K.	B1.0 C09B		
Gmeiner Confiserie & Kaffeehausunternehmen	B1.0 C16		
Bredemeijer Group B.V.	B1.0 C20		
Feuer & Glas OHG	B1.0 C22		
Schusters Spezialitäten GbR	B1.0 C23		
Ahland Handelsagentur oHG	B1.0 C24		
Ship it GmbH	B1.0 D01A		
Knut Hansen Gin (4anchors OHG)	B1.0 D01B		

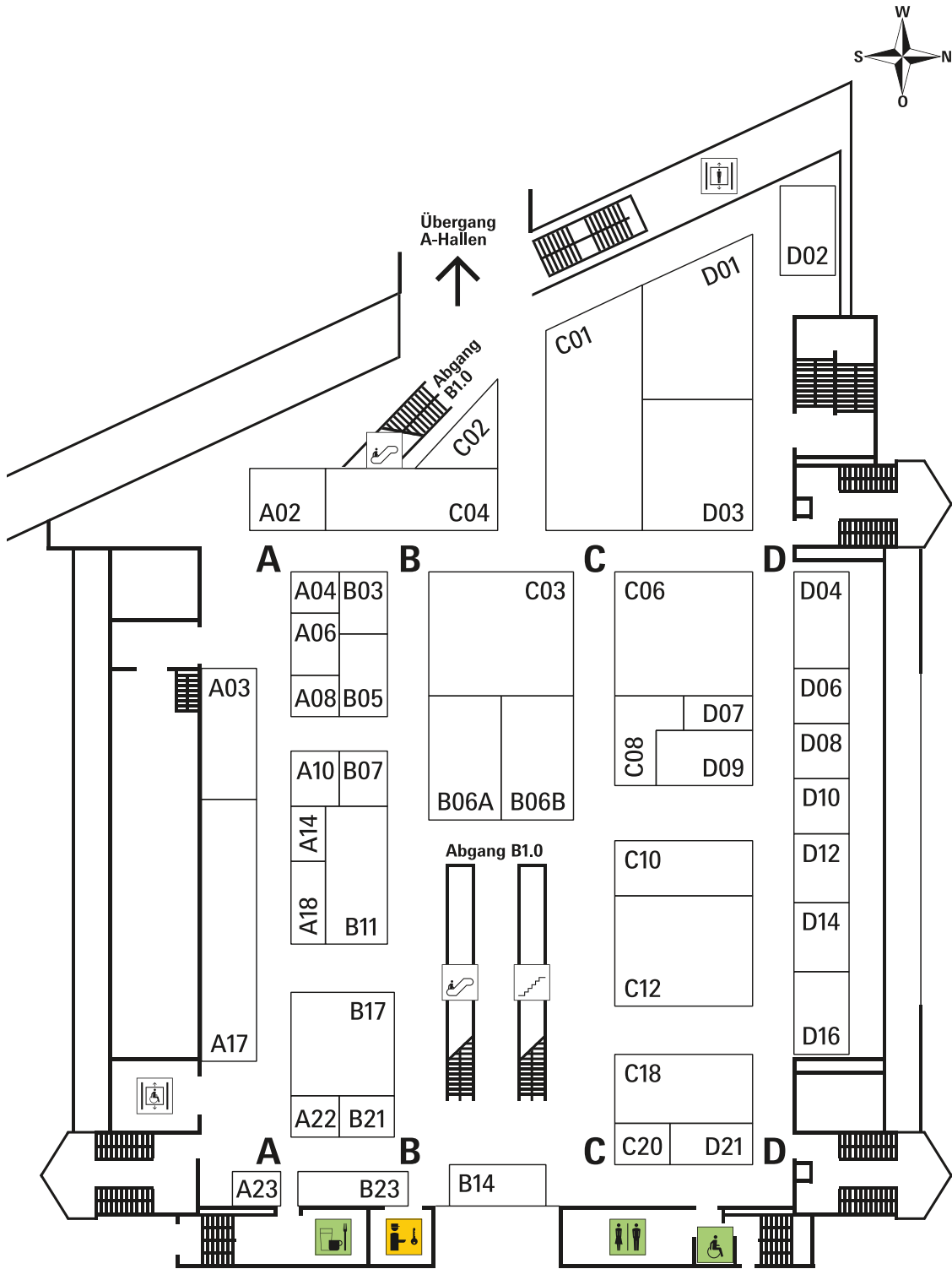

Stand 3. 12. 2018

alphabetisch

ARS Albrechts	
Raritäten & Spezialitäten GmbH	B1.1 D07
Barrique GmbH	B1.1 C08
Heinr. Böker Baumwerk GmbH Solingen	B1.1 D02
Handelsvertretung CDH Rolf Bunte	B1.1 B23
Christine Berger GmbH & Co. KG	B1.1 D12
Collectors Corner Inh. Susanne Maak e.K.	B1.1 C10
DreiMeister-Spezialitäten Hans Schröder GmbH & Co. KG	B1.1 C02
Essig, Öl & Co. Franchise GmbH	B1.1 C03
Feelino GmbH	B1.1 A08
Freude am Genuss GmbH	B1.1 A10
GEFU GmbH	B1.1 A17
Hattesens Konfektfabrik ApS	B1.1 A20
Ad.Hibben GmbH	B1.1 B14
honeyfaktor Paul Büki	B1.1 A19
Island Spezialitäten GbR	B1.1 A23
Kremers GmbH	B1.1 D14
LASSE LAKRITS - natürlich Lecker	B1.1 D04
LAUX GmbH	B1.1 C12
Le Creuset GmbH	B1.1 A17
lieb&lecker Svenja Moll	B1.1 A21
Lindner Porzellanfabrik KG	B1.1 D09
MAGU GmbH	B1.1 B06B
Mila GmbH	B1.1 B11
Müller Handelsagentur CDH Inhaber: Thomas Müller	B1.1 D03
Paul Nagel GmbH & Co. KG	B1.1 B06A
Nordic Gourmet Factory ApS	B1.1 A04
Oleio GmbH	B1.1 A02
Opus - Casa e Decorì	B1.1 D21
Maren Perleberg	B1.1 B17
PR Chokolade A/S	B1.1 D08
Richter exklusiv e.K.	B1.1 C20
Rinama GmbH	B1.1 C04
Salzwerk Berlin	B1.1 A18
SAXONIA Feinsteinzeug Manufaktur OHG	B1.1 A06
SCANPAN A/S	B1.1 D16
spiceboys-Gewürz Manufaktur Inh. Klaus Stickdorn	B1.1 A14
Städter GmbH	B1.1 A03
Strandküche Gewürzmanufaktur GmbH	B1.1 D06
TEE-MAASS Theodor Maass GmbH	B1.1 C01
Teehandel Wordtmann GmbH	B1.1 B19
Töpferhof Gramann in Römhild GmbH	B1.1 B03
UniKate / Dat lütte Tüdelband Inh. Monika Stumpf	B1.1 B05
VICTORINOX AG	B1.1 C18
Wajos GmbH	B1.1 C06
Wally and Whiz ApS	B1.1 B07
Wegter Consumenten B.V.	B1.1 D01
WUNASIA Handelsgesellschaft mbH	B1.1 A22
YUMMII YUMMII	B1.1 B21
Der Zuckerbäcker GmbH	B1.1 D10

nach Standnummer

Oleio GmbH	B1.1 A02
Städter GmbH	B1.1 A03
Nordic Gourmet Factory ApS	B1.1 A04
SAXONIA Feinsteinzeug Manufaktur OHG	B1.1 A06
Feelino GmbH	B1.1 A08
Freude am Genuss GmbH	B1.1 A10
spiceboys-Gewürz Manufaktur Inh. Klaus Stickdorn	B1.1 A14
GEFU GmbH	B1.1 A17
Le Creuset GmbH	B1.1 A17
Salzwerk Berlin	B1.1 A18
honeyfaktor Paul Büki	B1.1 A19
Hattesens Konfektfabrik ApS	B1.1 A20
lieb&lecker Svenja Moll	B1.1 A21
WUNASIA Handelsgesellschaft mbH	B1.1 A22
Island Spezialitäten GbR	B1.1 A23
Töpferhof Gramann in Römhild GmbH	B1.1 B03
UniKate / Dat lütte Tüdelband Inh. Monika Stumpf	B1.1 B05
Paul Nagel GmbH & Co. KG	B1.1 B06A
MAGU GmbH	B1.1 B06B
Wally and Whiz ApS	B1.1 B07
Mila GmbH	B1.1 B11
Ad.Hibben GmbH	B1.1 B14
Maren Perleberg	B1.1 B17
Teehandel Wordtmann GmbH	B1.1 B19
YUMMII YUMMII	B1.1 B21
Handelsvertretung CDH Rolf Bunte	B1.1 B23
TEE-MAASS Theodor Maass GmbH	B1.1 C01
DreiMeister-Spezialitäten Hans Schröder GmbH & Co. KG	B1.1 C02
Essig, Öl & Co. Franchise GmbH	B1.1 C03
Rinama GmbH	B1.1 C04
Wajos GmbH	B1.1 C06
Barrique GmbH	B1.1 C08
Collectors Corner Inh. Susanne Maak e.K.	B1.1 C10
LAUX GmbH	B1.1 C12
VICTORINOX AG	B1.1 C18
Richter exklusiv e.K.	B1.1 C20
Wegter Consumenten B.V.	B1.1 D01
Heinr. Böker Baumwerk GmbH Solingen	B1.1 D02
Müller Handelsagentur CDH Inhaber: Thomas Müller	B1.1 D03
LASSE LAKRITS - natürlich Lecker	B1.1 D04
Strandküche Gewürzmanufaktur GmbH	B1.1 D06
ARS Albrechts Raritäten & Spezialitäten GmbH	B1.1 D07
PR Chokolade A/S	B1.1 D08
Lindner Porzellanfabrik KG	B1.1 D09
Der Zuckerbäcker GmbH	B1.1 D10
Christine Berger GmbH & Co. KG	B1.1 D12
Kremers GmbH	B1.1 D14
SCANPAN A/S	B1.1 D16
Opus - Casa e Decorì	B1.1 D21

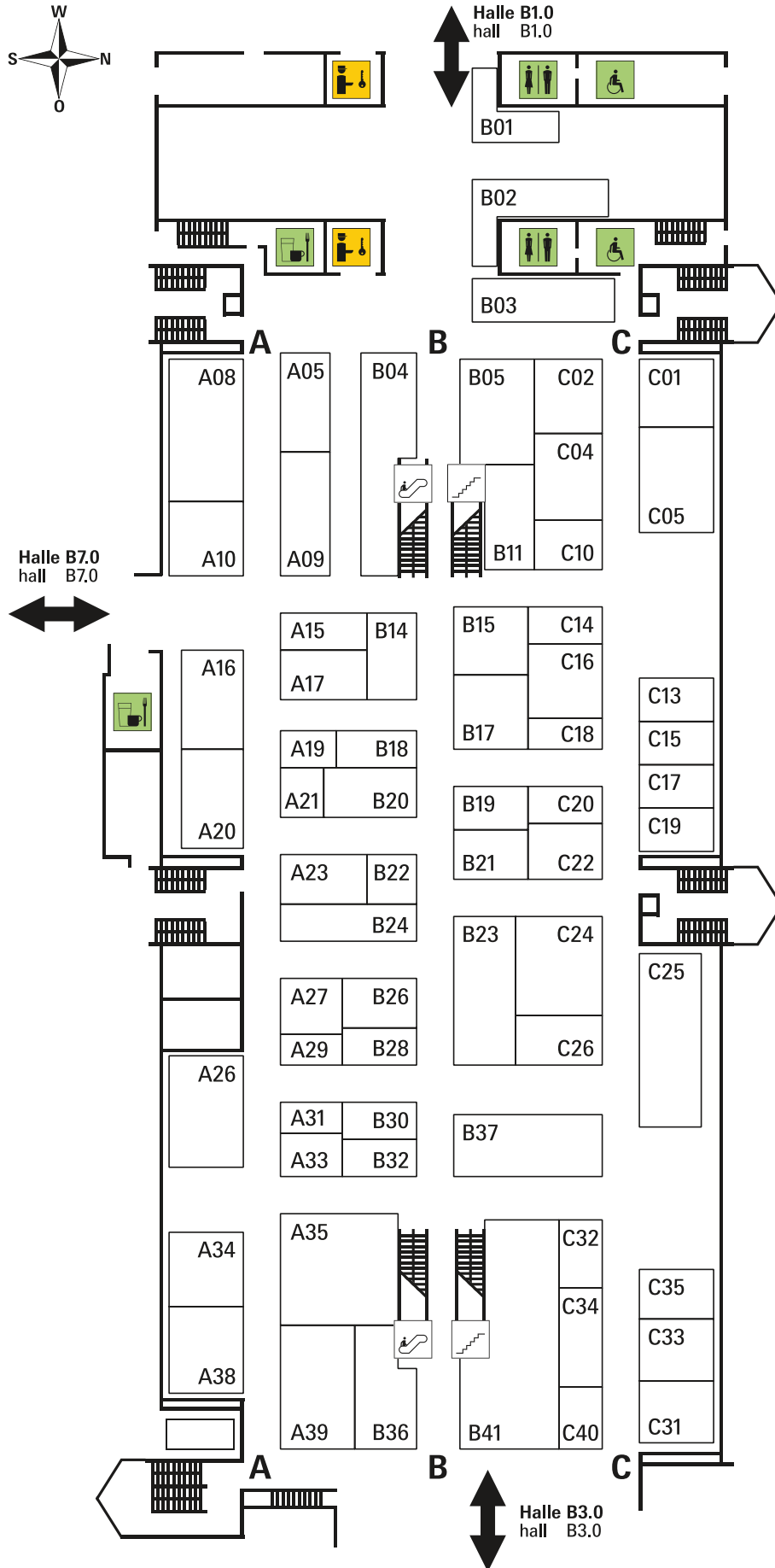

Stand 3. 12. 2018

alphabetisch

Accentra GmbH & Co. KG	B2.0 B04	RIC DENMARK ApS	B2.0 A23
Konrad Arnold GmbH & Co. KG	B2.0 B20	Royal Orient Cosmetic GmbH	B2.0 C14
Auskin Europe Ltd.	B2.0 C22	SABODesign GmbH	B2.0 B36
Bahne & Co.	B2.0 B02	Saebevaerkstedet v/Lone	
Hans Baier e.K. Inh. Alina Baier	B2.0 B22	Sarto Pedersen	B2.0 A23
BECKER-MANICURE SOLINGEN		Scented Cubes - Wolfgang Kanzler	B2.0 B32
Siegfried Becker e.K.	B2.0 B15	Handelsagentur Scheer	B2.0 B19
BECO Beermann GmbH & Co. KG	B2.0 A20	Schröder Packfix GmbH	B2.0 B20
Bellissima Creation GmbH	B2.0 A10	SCHUMM	B2.0 C33
Bergholz Holzimport GmbH	B2.0 C25	SecWal	B2.0 C20
BO Cosmetic GmbH	B2.0 A09	SHOES AND MORE Gerhard Oswald	B2.0 C01
Get fresh Cosmetics Ltd.		Sofabrik GmbH	B2.0 C31
BOMB COSMETICS	B2.0 C05	Spa Vivent Vertriebs GmbH	B2.0 A21
Jerome Canlorbe SAS -		Spang GmbH	B2.0 A35
Bombata - Nava Design - MH Way	B2.0 C34	pajoma, Ingo Steyer KG	B2.0 A27
Casada Deutschland GmbH	B2.0 C32	Top Team Collection GmbH	B2.0 A05
Cheerful Candle / Duft & Raum		Traumduft GmbH	B2.0 B21
Inh.: Miriam Haubold	B2.0 C26	Village Cosmetics GmbH & Co. KG	B2.0 B11
Leder Waldherr CLM, Cinino,		WILLMANNNS - Schöne Dinge &	
Bayern Bag	B2.0 A34	Genuss, Jürgen Ottstadt	B2.0 C19
Croll & Denecke GmbH	B2.0 B30	WR-Accessoires GmbH	B2.0 A19
Werner Czarnecki	B2.0 B24	Yankee Candle Deutschland GmbH	B2.0 C24
D.A.N.S	B2.0 C17		
Dansk Smykkekunst A/S	B2.0 B02		
Dernier GmbH	B2.0 A26		
Dugros B.V.	B2.0 A08		
Ebarrito S.r.l.	B2.0 A16		
Eja International ApS	B2.0 B37		
Eja International ApS	B2.0 B41		
FASHY GmbH Produktion und Vertrieb	B2.0 C16		
Fausto GmbH & Co. KG	B2.0 B17		
Frosch & Rabe	B2.0 A29		
Goose Creek Candle Deutschland			
Inhaber: Miriam Haubold	B2.0 C26		
Gosch Shoes GbR	B2.0 C10		
happy rain Würflingsdobler GmbH	B2.0 C02		
heller vertrieb	B2.0 B18		
HEMSLEY LIVING Jens Köster	B2.0 B01		
HL Lederwaren B.V.	B2.0 A17		
India Basar, Fa. Steffi Sharma	B2.0 B28		
Richard Jäger Inh. Doris Becker	B2.0 A15		
Kerzenfarm Hahn e. K.	B2.0 B23		
Kolter GmbH	B2.0 A31		
Konert Home GmbH	B2.0 B05		
Kathrin Kynast e.K. Import - Export	B2.0 A39		
Landleder GmbH	B2.0 C35		
Larsson Interior	B2.0 A23		
LEIKOR Direktimporte			
Petra Leiers-Kording	B2.0 B03		
Like it a lot	B2.0 A38		
Der Lindwurm HGmbH	B2.0 A33		
MaBe	B2.0 C40		
Medialmed - Andreas Spittler	B2.0 C04		
MOOSMED Natural Cosmetics GmbH	B2.0 B14		
Naturfell-Paradies Hans-Peter Kloss	B2.0 B26		
Naturfreunde MV GmbH	B2.0 C18		

Halle B2 Hall B2

Haus & Garten
Home & Garden

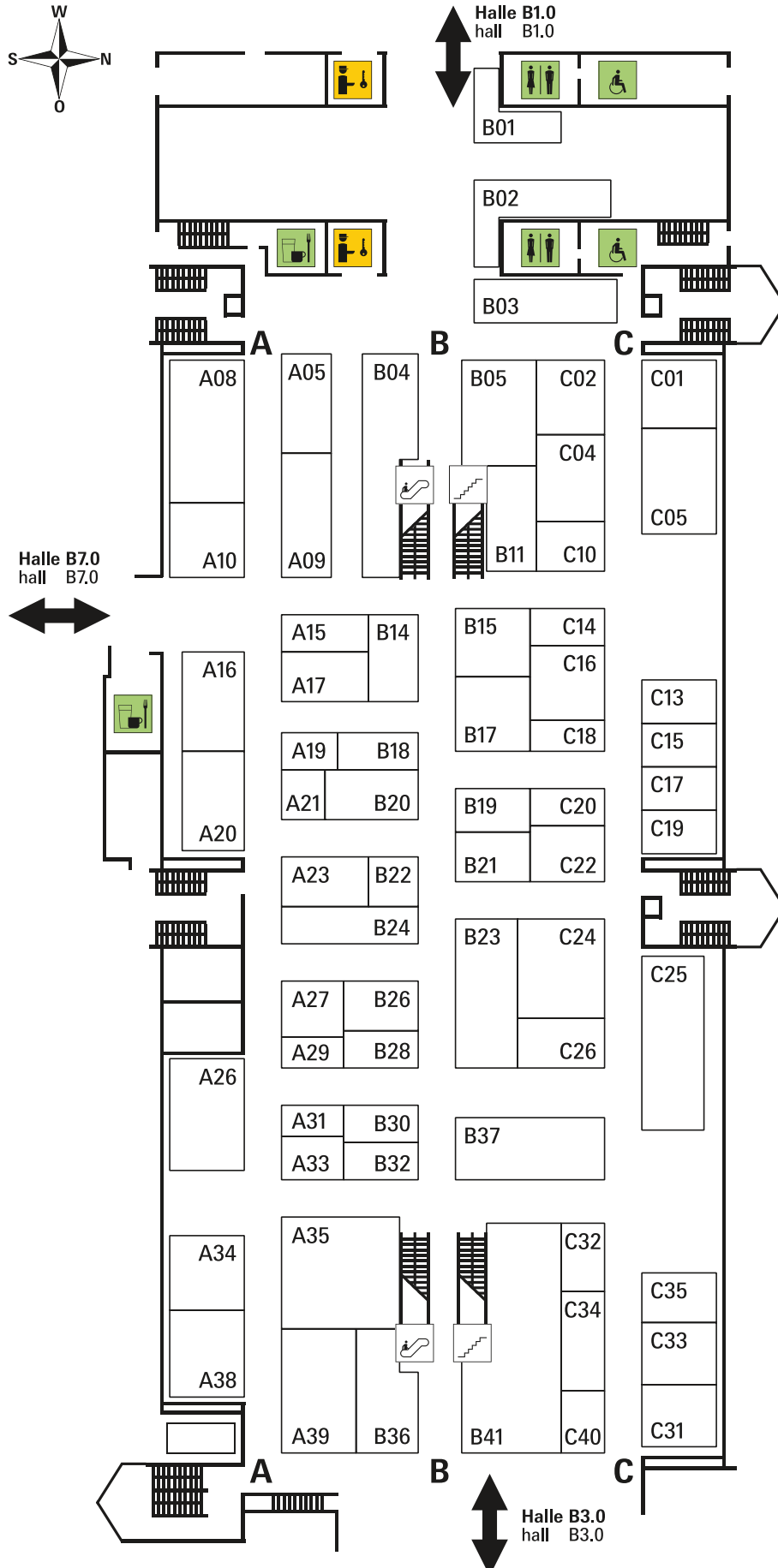

Stand 3. 12. 2018

nach Standnummer

Top Team Collection GmbH	B2.0 A05	Gosch Shoes GbR	B2.0 C10
Dugros B.V.	B2.0 A08	Royal Orient Cosmetic GmbH	B2.0 C14
BO Cosmetic GmbH	B2.0 A09	FASHY GmbH Produktion und Vertrieb	B2.0 C16
Bellissima Creation GmbH	B2.0 A10	D.A.N.S	B2.0 C17
Richard Jäger Inh. Doris Becker	B2.0 A15	Naturfreunde MV GmbH	B2.0 C18
Ebarrito S.r.l.	B2.0 A16	WILLMANNNS - Schöne Dinge & Genuss, Jürgen Ottstadt	B2.0 C19
HL Lederwaren B.V.	B2.0 A17	SecWal	B2.0 C20
WR-Accessoires GmbH	B2.0 A19	Auskin Europe Ltd.	B2.0 C22
BECO Beermann GmbH & Co. KG	B2.0 A20	Yankee Candle Deutschland GmbH	B2.0 C24
Spa Vivent Vertriebs GmbH	B2.0 A21	Bergholz Holzimport GmbH	B2.0 C25
Larsson Interior	B2.0 A23	Cheerful Candle / Duft & Raum Inh.: Miriam Haubold	B2.0 C26
RIC DENMARK ApS	B2.0 A23	Goose Creek Candle Deutschland Inhaber: Miriam Haubold	B2.0 C26
Saebevaerkstedet v/Lone		Sofabrik GmbH	B2.0 C31
Sarto Pedersen	B2.0 A23	Casada Deutschland GmbH	B2.0 C32
Dernier GmbH	B2.0 A26	SCHUMM	B2.0 C33
pajoma, Ingo Steyer KG	B2.0 A27	Jerome Canlorbe SAS - Bombata - Nava Design - MH Way	B2.0 C34
Frosch & Rabe	B2.0 A29	Landleder GmbH	B2.0 C35
Kolter GmbH	B2.0 A31	MaBe	B2.0 C40
Der Lindwurm HGmbH	B2.0 A33		
Leder Waldherr CLM, Cinino, Bayern Bag	B2.0 A34		
Spang GmbH	B2.0 A35		
Like it a lot	B2.0 A38		
Kathrin Kynast e.K. Import - Export	B2.0 A39		
HEMSLEY LIVING Jens Köster	B2.0 B01		
Bahne & Co.	B2.0 B02		
Dansk Smykkekunst A/S	B2.0 B02		
LEIKOR Direktimporte Petra Leiers-Kording	B2.0 B03		
Accentra GmbH & Co. KG	B2.0 B04		
Konert Home GmbH	B2.0 B05		
Village Cosmetics GmbH & Co. KG	B2.0 B11		
MOOSMED Natural Cosmetics GmbH	B2.0 B14		
BECKER-MANICURE SOLINGEN Siegfried Becker e.K.	B2.0 B15		
Fausto GmbH & Co. KG	B2.0 B17		
heller vertrieb	B2.0 B18		
Handelsagentur Scheer	B2.0 B19		
Konrad Arnold GmbH & Co. KG	B2.0 B20		
Schröder Packfix GmbH	B2.0 B20		
Traumduft GmbH	B2.0 B21		
Hans Baier e.K. Inh. Alina Baier	B2.0 B22		
Kerzenfarm Hahn e. K.	B2.0 B23		
Werner Czarnecki	B2.0 B24		
Naturfell-Paradies Hans-Peter Kloss	B2.0 B26		
India Basar, Fa. Steffi Sharma	B2.0 B28		
Croll & Denecke GmbH	B2.0 B30		
Scented Cubes - Wolfgang Kanzler	B2.0 B32		
SABODesign GmbH	B2.0 B36		
Eja International ApS	B2.0 B37		
Eja International ApS	B2.0 B41		
SHOES AND MORE Gerhard Oswald	B2.0 C01		
happy rain Würflingsdobler GmbH	B2.0 C02		
Medialmed - Andreas Spittler	B2.0 C04		
Get fresh Cosmetics Ltd. BOMB COSMETICS	B2.0 C05		

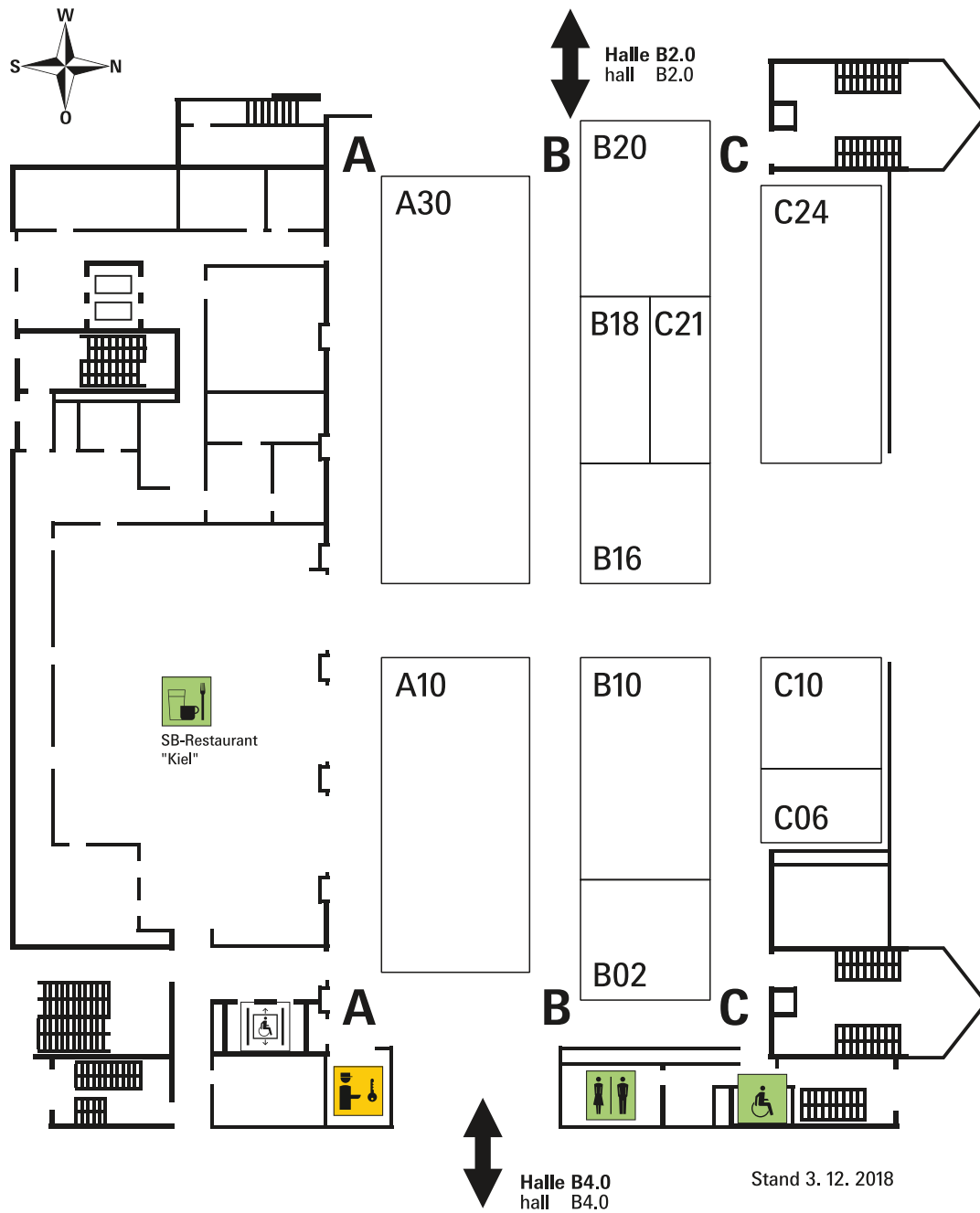

alphabetisch

Bell' Arte Thomas Gröner Einzelfirma	B3.0 B20
Candle Factory, Dennis Gödeke e.K.	B3.0 C06
Colours in Motion GmbH	B3.0 B02
Ferrum Art Design GmbH & Co. KG	B3.0 B10
Figurendiscounter GmbH & Co. KG	B3.0 C24
Five Oaks Int. Europe Ltd.	B3.0 C21
Handelsagentur Thomas Mrowka	B3.0 B20
San Marco GmbH	B3.0 A10
San Marco GmbH	B3.0 A30
Vidroflor Warenhandels GmbH	B3.0 B16
Zauberblume GmbH	B3.0 B18

nach Standnummer

San Marco GmbH	B3.0 A10
San Marco GmbH	B3.0 A30
Colours in Motion GmbH	B3.0 B02
Ferrum Art Design GmbH & Co. KG	B3.0 B10
Vidroflor Warenhandels GmbH	B3.0 B16
Zauberblume GmbH	B3.0 B18
Bell' Arte Thomas Gröner Einzelfirma	B3.0 B20
Handelsagentur Thomas Mrowka	B3.0 B20
Candle Factory, Dennis Gödeke e.K.	B3.0 C06
Five Oaks Int. Europe Ltd.	B3.0 C21
Figurendiscounter GmbH & Co. KG	B3.0 C24

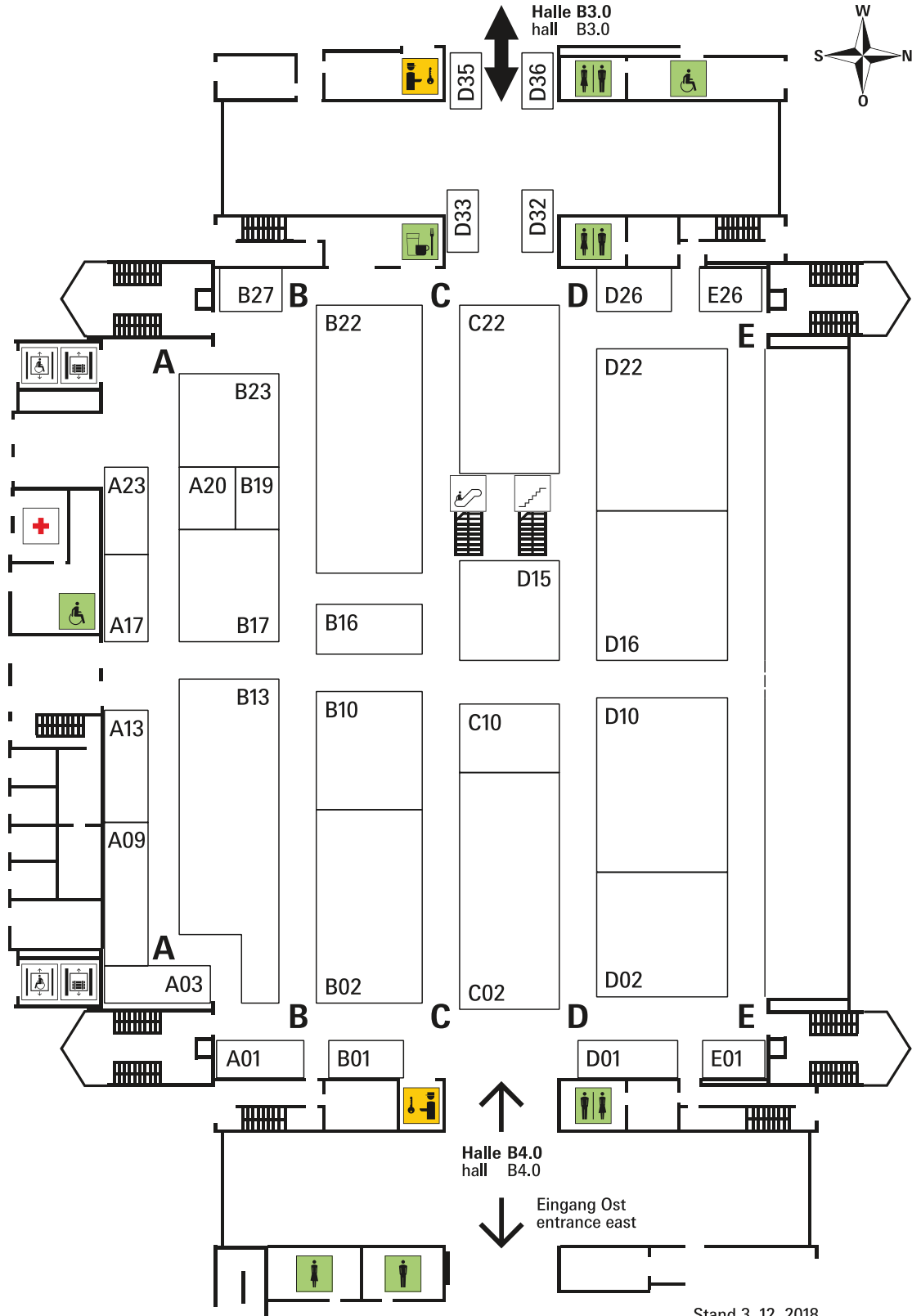

Stand 3. 12. 2018

alphabetisch

Badeko GmbH	B4.0 B22
Barracuda Stylecompany, Ronny Weinert	B4.0 D02
Beauty Group, Frank Schmidt Import	B4.0 C22
Glasbläserei Christian Bernschein	B4.0 B27
Bettin Handelsgesellschaft mbH & Co. KG	B4.0 D10
bynew Möbel & Dekoration Nils Neumann	B4.0 B19
CLASSICO Modern Living	B4.0 B17
Decostar	B4.0 C02
EMKA - Papier und Folienverarbeitings GmbH	B4.0 A13
FW-Glas GmbH Frankenwaldglas	B4.0 D32
FW-Glas GmbH Frankenwaldglas	B4.0 D33
Glatzel & Glatzel	B4.0 A17
Goldbach Geschenkartikel GmbH	B4.0 B13
Herrnhuter Sterne GmbH	B4.0 A20
Hundt Handels GmbH, Zierrat Berlin - Handarbeit fair gehandelt	B4.0 D36
Ideenwerkstatt, B.G.F.GmbH	B4.0 B01
Jambavan Inh.: Monika Bäres	B4.0 A23
Jodeco Glass B.V.	B4.0 B10
Jodeco Glass B.V.	B4.0 B16
Klein Metalldesign Steffen Klein	B4.0 A01
Krenz GmbH	B4.0 D15
Krenz GmbH	B4.0 D16
Johannes LUCHT GmbH & CO. KG	B4.0 A09
Peter Lüders - Creativ Concept	B4.0 D26
Helmut Martin e.K.	B4.0 B23
Otto Keramik Inh. Otto Gerharz	B4.0 D01
Phoenix TT GmbH & Co. KG	B4.0 C10
Pustablume GmbH	B4.0 B02
Georg Schäfer GmbH & Co. Handels KG	B4.0 D01
Schmidt GmbH Floristik & Dekorationsgroßhandel	B4.0 D22
Schmidt GmbH Floristik & Dekorationsgroßhandel	B4.0 E26
Richard Sellmer Verlag KG	B4.0 E01
Spieluhrenwelt - MMM GmbH	B4.0 A03

nach Standnummer

Klein Metalldesign Steffen Klein	B4.0 A01
Spieluhrenwelt - MMM GmbH	B4.0 A03
Johannes LUCHT GmbH & CO. KG	B4.0 A09
EMKA - Papier und Folienverarbeitings GmbH	B4.0 A13
Glatzel & Glatzel	B4.0 A17
Herrnhuter Sterne GmbH	B4.0 A20
Jambavan Inh.: Monika Bäres	B4.0 A23
Ideenwerkstatt, B.G.F.GmbH	B4.0 B01
Pustablume GmbH	B4.0 B02
Jodeco Glass B.V.	B4.0 B10
Goldbach Geschenkartikel GmbH	B4.0 B13
Jodeco Glass B.V.	B4.0 B16
CLASSICO Modern Living	B4.0 B17
bynew Möbel & Dekoration Nils Neumann	B4.0 B19
Badeko GmbH	B4.0 B22
Helmut Martin e.K.	B4.0 B23
Glasbläserei Christian Bernschein	B4.0 B27
Decostar	B4.0 C02
Phoenix TT GmbH & Co. KG	B4.0 C10
Beauty Group, Frank Schmidt Import	B4.0 C22
Otto Keramik Inh. Otto Gerharz	B4.0 D01
Georg Schäfer GmbH & Co. Handels KG	B4.0 D01
Barracuda Stylecompany, Ronny Weinert	B4.0 D02
Bettin Handelsgesellschaft mbH & Co. KG	B4.0 D10
Krenz GmbH	B4.0 D15
Krenz GmbH	B4.0 D16
Schmidt GmbH Floristik & Dekorationsgroßhandel	B4.0 D22
Peter Lüders - Creativ Concept	B4.0 D26
FW-Glas GmbH Frankenwaldglas	B4.0 D32
FW-Glas GmbH Frankenwaldglas	B4.0 D33
Hundt Handels GmbH, Zierrat Berlin - Handarbeit fair gehandelt	B4.0 D36
Richard Sellmer Verlag KG	B4.0 E01
Schmidt GmbH Floristik & Dekorationsgroßhandel	B4.0 E26

Halle B5 Hall B5

Haus & Garten / Souvenirs
Home & Garden / Souvenirs

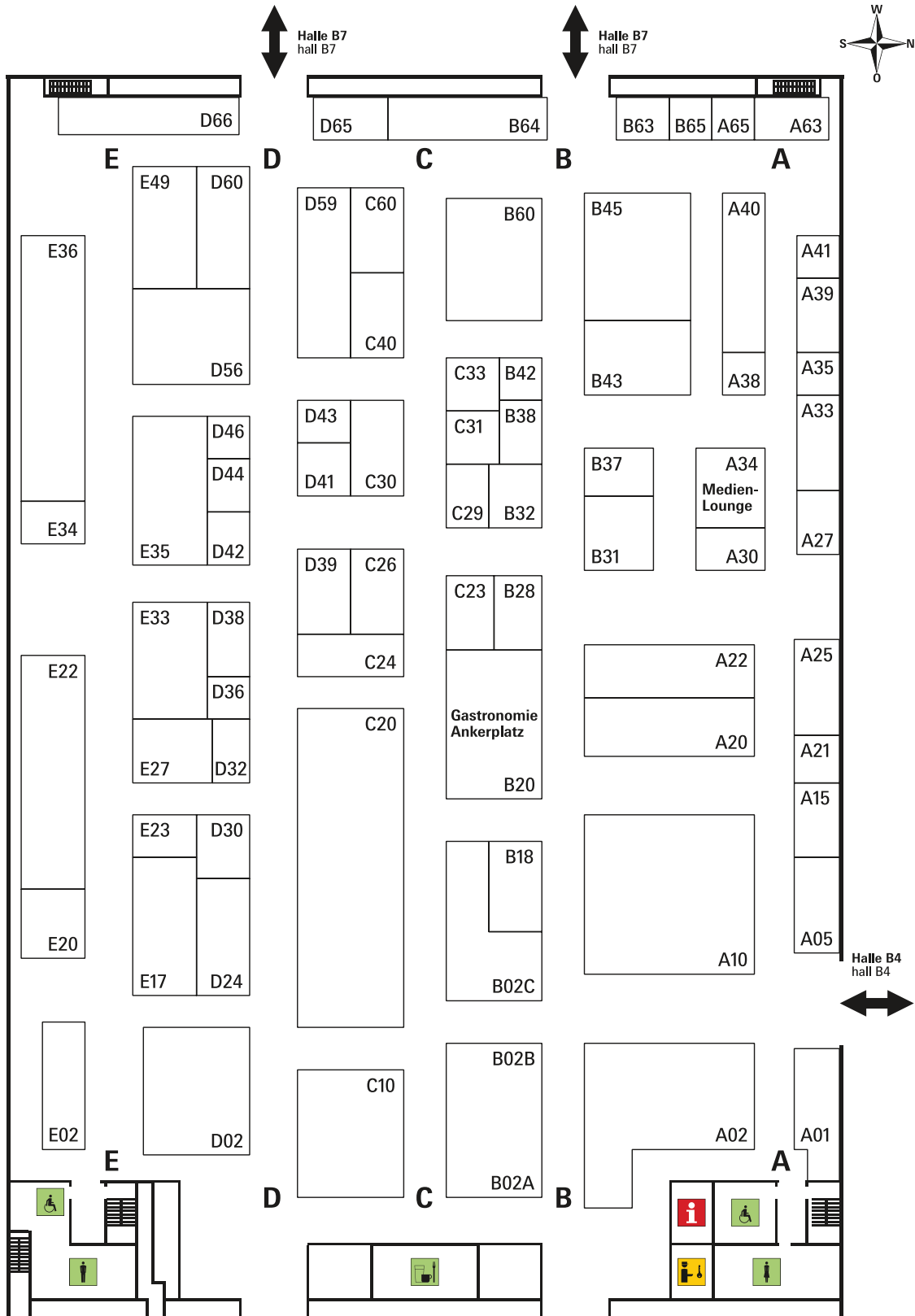

Stand 3. 12. 2018

alphabetisch

andrea design GmbH & Co. KG	B5.0 A20	Michel Toys Handels-GmbH	B5.0 D02
ARTenreich GLAS Kunstwerkstatt		Montag GmbH	B5.0 E17
Artenreich	B5.0 A30	Nautic Hamburg	
Artesania Esteban Ferrer S.L.	B5.0 D59	Maritime Handels GmbH & Co.KG	B5.0 C60
Bio Masse Trocknung GmbH Pferdolit	B5.0 A41	Pape Kunstgewerbe GmbH & Co. KG	B5.0 A05
Blechwaren Fabrik		Passerelle Design BVBA	B5.0 A21
Braunschweig GmbH	B5.0 D44	PD Geschenke Inh. Jianrong Tu	B5.0 D38
Chr. Bollweg e.K.	B5.0 B02A	Erwin Pfaff Geschenkartikel e.K.	B5.0 E23
Chr. Bollweg e.K.	B5.0 B02B	Pfronten-Schmuck GmbH	B5.0 D66
Chr. Bollweg e.K.	B5.0 B02C	Horst Platow - Muscheln und Geschenkartikel Import und Export	B5.0 E33
Bukowski Design, Kunst und Keramik, Rainbow, TAZ TRADE-Handelsagentur		Posiwio GmbH & Co. Vertriebs KG	B5.0 A10
Janina Dembowa	B5.0 E02	Power Gift s.c. Maciej Blaszczyk, Ireneusz Sadowski	B5.0 D65
Casa Bonita Art of Glass	B5.0 B63	PPS-Schimmel GmbH	B5.0 B28
CASSIA - the decoration company		Christian Prenzler - Steintechniker und Bildhauer	B5.0 D32
Lars Spreckelmeyer e.K.	B5.0 A22	Privat Collection	B5.0 B64
Ceramics World	B5.0 D43	RAHLF GmbH	B5.0 E36
Colours & Green B.V.	B5.0 B45	Handelsagentur Ralf Richter	B5.0 D30
Cottage Garden decoration		Romantik Garten GbR	
Inh. Matthias Däumler	B5.0 A15	Oliver Szijarto Rita Szijarto	B5.0 A65
Creation Gross Inhaber Markus Gross	B5.0 E27	SEA-CLUB Handels-GmbH	B5.0 E49
CRG GmbH / Kräuterwerkstatt	B5.0 C29	Seyko-Geschenke Inh. Heiko Seyferth	B5.0 B18
Cutting Brothers,		Shona-Art	B5.0 B38
Wiebe Textil GmbH & Co, KG	B5.0 C23	SL. GESCHENKE, Stephan Lau	B5.0 E35
DecorBis Marek Rajkiewicz	B5.0 B32	Soap & Gifts BVBA	B5.0 C31
Dressler & Zimmerhagl KG	B5.0 E17	Sonnenglas	B5.0 A35
Enesco Limited	B5.0 A25	Stellaverde GmbH - L'Erbolario	B5.0 C30
Exner GmbH	B5.0 C20	Tangoo Deko und Geschenke Inh.: Winfried Hutzler	B5.0 A40
Fast Key International (Germany) GmbH	B5.0 A63	Tawa Albert Weishaupt AG	B5.0 E17
Fiebiger Floristik GmbH		TERRA Software GmbH	B5.0 B65
Import-Export Großhandel	B5.0 C10	TRENDS Claus Lehmann	B5.0 C26
Flora Trade Parc Venlo	B5.0 A38	United Labels AG	B5.0 D24
Walter Fürhapter		VIB Very Important Baby®	B5.0 C33
Gesellschaft m.b.H. & Co. KG.	B5.0 D42	Vosteen Import Export GmbH	B5.0 A01
Handelsagentur Anne Garber		Vosteen Import Export GmbH	B5.0 A02
Inh. Lutz Garber	B5.0 D56	Waibel Collection	B5.0 B43
Goldline GmbH	B5.0 D56	Frank Wilhahn e.K.	B5.0 E22
HanseFlag GmbH	B5.0 D60	Willeke Leuchten Jan Willeke	B5.0 B42
Hansestil FAROL UG	B5.0 D36	Wunderle, Heike Bringemeier e.K.	B5.0 D46
Reinhold W. Heim GmbH & Co. KG	B5.0 E17	Zuco	B5.0 E17
Josef Hoffmann Porzellan- und Glasveredelung Inh. Heike Hoffmann	B5.0 E17		
Holthoff Leuchten GmbH & Co. KG	B5.0 D26		
Vertriebsagentur SH Stefan Holzmann	B5.0 E17		
Home Society B.V.	B5.0 B60		
Hublot Mode Marine (Exklusiver Distributor)	B5.0 D59		
Inis the Energy of the Sea	B5.0 B37		
Karena International Sprl	B5.0 A39		
KRÜGER MARITIM GmbH	B5.0 C40		
Drechslerei Kuhnert GmbH	B5.0 C24		
LA SIESTA GmbH	B5.0 D39		
Light Trend VOF	B5.0 A27		
Madleys	B5.0 B31		
Maj Isenkram ApS	B5.0 E20		
Metallgestaltung Müller	B5.0 A33		
MGM Meyer's göttliches Meublement Stefan Meyer	B5.0 D41		

Halle B5 Hall B5

Haus & Garten / Souvenirs
Home & Garden / Souvenirs

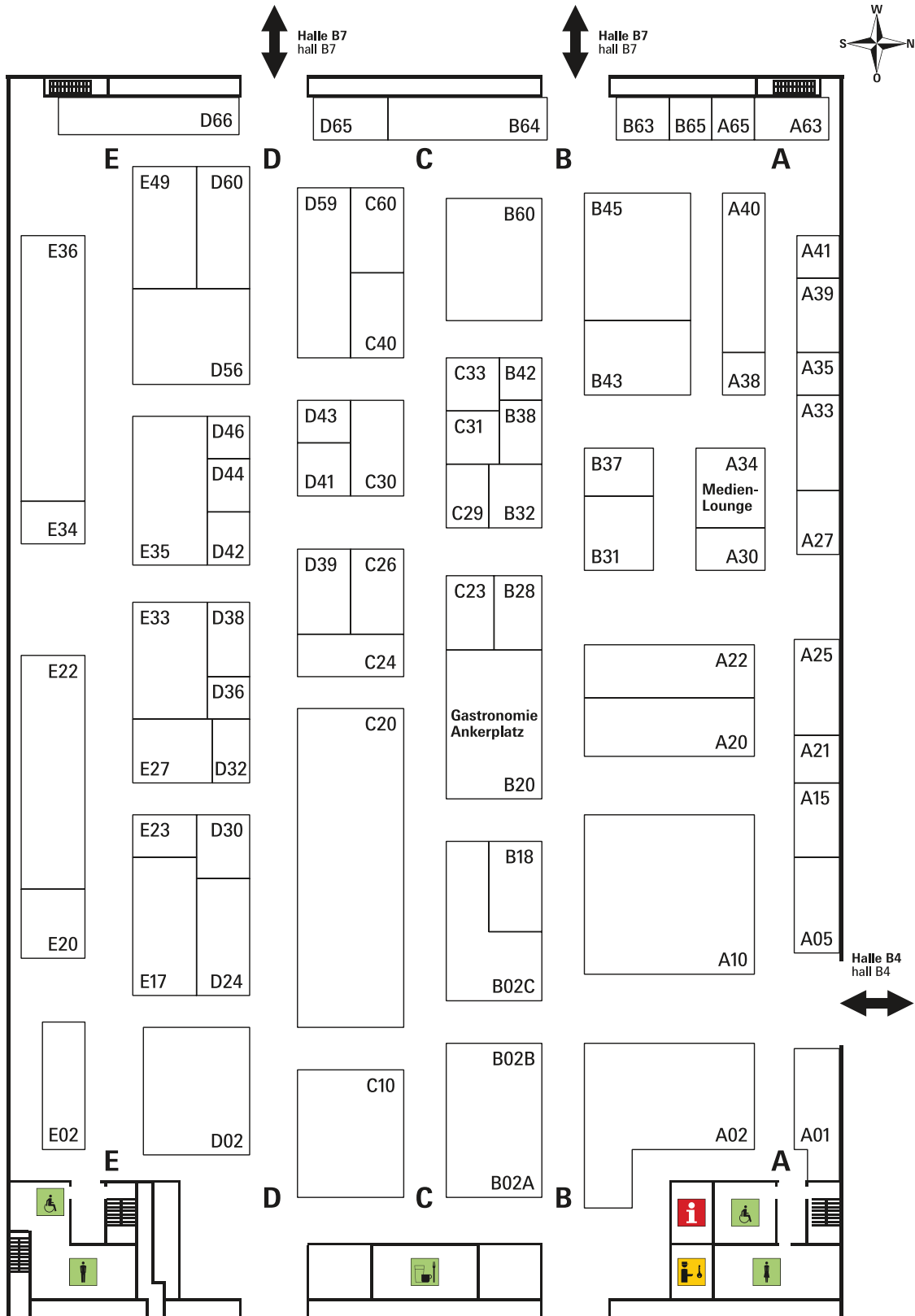

Stand 3. 12. 2018

nach Standnummer

Vosteen Import Export GmbH	B5.0 A01	Holthoff Leuchten GmbH & Co. KG	B5.0 D26
Vosteen Import Export GmbH	B5.0 A02	Handelsagentur Ralf Richter	B5.0 D30
Pape Kunstgewerbe GmbH & Co. KG	B5.0 A05	Christian Prenzler - Steintechniker und Bildhauer	B5.0 D32
Posiwio GmbH & Co. Vertriebs KG	B5.0 A10	Hansestil FAROL UG	B5.0 D36
Cottage Garden decoration Inh. Matthias Däumler	B5.0 A15	PD Geschenke Inh. Jianrong Tu	B5.0 D38
andrea design GmbH & Co. KG	B5.0 A20	LA SIESTA GmbH	B5.0 D39
Passerelle Design BVBA	B5.0 A21	MGM Meyer's göttliches Meublement Stefan Meyer	B5.0 D41
CASSIA - the decoration company Lars Spreckelmeyer e.K.	B5.0 A22	Walter Fürhapter Gesellschaft m.b.H. & Co. KG.	B5.0 D42
Enesco Limited	B5.0 A25	Ceramics World	B5.0 D43
Light Trend VOF	B5.0 A27	Blechwaren Fabrik Braunschweig GmbH	B5.0 D44
ARTenreich GLAS Kunstwerkstatt Artenreich	B5.0 A30	Wunderle, Heike Bringemeier e.K.	B5.0 D46
Metallgestaltung Müller	B5.0 A33	Handelsagentur Anne Garber Inh. Lutz Garber	B5.0 D56
Sonnenglas	B5.0 A35	Goldline GmbH	B5.0 D56
Flora Trade Parc Venlo	B5.0 A38	Artesania Esteban Ferrer S.L.	B5.0 D59
Karena International Sprl	B5.0 A39	Hublot Mode Marine (Exklusiver Distributor)	B5.0 D59
Tangoo Deko und Geschenke Inh.: Winfried Hutzler	B5.0 A40	HanseFlag GmbH	B5.0 D60
Bio Masse Trocknung GmbH Pferdolit	B5.0 A41	Power Gift s.c. Maciej Blaszczyk, Ireneusz Sadowski	B5.0 D65
Fast Key International (Germany) GmbH	B5.0 A63	Pffronten-Schmuck GmbH	B5.0 D66
Romantik Garten GbR Oliver Szijarto Rita Szijarto	B5.0 A65	Bukowski Design, Kunst und Keramik, Rainbow, TAZ TRADE-Handelsagentur Janina Dembowa	B5.0 E02
Chr. Bollweg e.K.	B5.0 B02A	Dressler & Zimmerhagl KG	B5.0 E17
Chr. Bollweg e.K.	B5.0 B02B	Reinhold W. Heim GmbH & Co. KG	B5.0 E17
Chr. Bollweg e.K.	B5.0 B02C	Josef Hoffmann Porzellan- und Glasveredelung Inh. Heike Hoffmann	B5.0 E17
Seyko-Geschenke Inh. Heiko Seyferth	B5.0 B18	Vertriebsagentur SH Stefan Holzmann	B5.0 E17
PPS-Schimmel GmbH	B5.0 B28	Montag GmbH	B5.0 E17
Madleys	B5.0 B31	Tawa Albert Weishaupt AG	B5.0 E17
DecorBis Marek Rajkiewicz	B5.0 B32	Zuco	B5.0 E17
Inis the Energy of the Sea	B5.0 B37	Maj Isenkram ApS	B5.0 E20
Shona-Art	B5.0 B38	Frank Wilhahn e.K.	B5.0 E22
Willeke Leuchten Jan Willeke	B5.0 B42	Erwin Pfaff Geschenkartikel e.K.	B5.0 E23
Waibel Collection	B5.0 B43	Creation Gross Inhaber Markus Gross	B5.0 E27
Colours & Green B.V.	B5.0 B45	Horst Platow - Muscheln und Geschenkartikel Import und Export	B5.0 E33
Home Society B.V.	B5.0 B60	SL. GESCHENKE, Stephan Lau	B5.0 E35
Casa Bonita Art of Glass	B5.0 B63	RAHLF GmbH	B5.0 E36
Privat Collection	B5.0 B64	SEA-CLUB Handels-GmbH	B5.0 E49
TERRA Software GmbH	B5.0 B65		
Fiebiger Floristik GmbH Import-Export Großhandel	B5.0 C10		
Exner GmbH	B5.0 C20		
Cutting Brothers, Wiebe Textil GmbH & Co, KG	B5.0 C23		
Drechslerei Kuhnert GmbH	B5.0 C24		
TRENDS Claus Lehmann	B5.0 C26		
CRG GmbH / Kräuterwerkstatt	B5.0 C29		
Stellaverde GmbH - L'Erbolario	B5.0 C30		
Soap & Gifts BVBA	B5.0 C31		
VIB Very Important Baby®	B5.0 C33		
KRÜGER MARITIM GmbH	B5.0 C40		
Nautic Hamburg Maritime Handels GmbH & Co.KG	B5.0 C60		
michel toys Handels-GmbH	B5.0 D02		
United Labels AG	B5.0 D24		

Halle B7 Hall B7

Schmuck & Mode
Jewellery & Fashion



alphabetisch

Accessoires and More Andreas Nickel	B7.0 A22	Estelle e.K.	B7.0 D55
ADI-Modeschmuck		Estelle Silver - Tanja Baur	B7.0 G46
Inh. Sabine Schifferer	B7.0 F39	Eva Stone & Glitter Kazimierz Szyszko, Ewa Szyszko	B7.0 G33
A. Ahmaddy Tücher und Schals	B7.0 A62	Fashion Company Aps	B7.0 G31
AJOLA® GbR	B7.0 F34	Flomax Naturmode GmbH	B7.0 B56
ALKENA GmbH	B7.0 D45	Fortschritt-Berlin e.K.	B7.0 C56
Aluna - Schmuckdesign		Fun of Europe Handels GmbH	B7.0 D54
Einzelunternehmen Regina Rösler	B7.0 G44	Funny Girl Z. Hill	B7.0 C52
Amberworld Bernsteinmanufaktur		GA Outlet Fashion GmbH	B7.0 A46
Hamburg Jens von Holt e.K.	B7.0 D15	Geo-Expert Michael Vogt	B7.0 G21
AMBRA Schmuck	B7.0 A19	Siegfried Giede GmbH	B7.0 G41
AnRa Mode GmbH	B7.0 A49	GO2 GmbH	B7.0 B10
Aqua dulce v/Janne Lisberg Fisker	B7.0 B34	Goldline GmbH	B7.0 C03
Ariana Lapis e.K.	B7.0 E37	Goldline GmbH	B7.0 D51
AS Bekleidungswerk GmbH	B7.0 D43	Michael Gori - Joid'Art, Barcelona	B7.0 B30
Aslan Bijuteri		Green Factory Colombia GmbH	B7.0 F54
Taki San. ve Dis Tic. Ltd. Sti	B7.0 F49	Grethe Winter UG	B7.0 E43
Atlantis Accessories GmbH	B7.0 F30	Gubo Schmuck Inh. Thomas Gubo	B7.0 F03
Australian Fashion House GmbH	B7.0 D41	HaJuNa GbR	B7.0 A37
B-Latitude Inh.: Françoise Saegbrecht	B7.0 F20	Handelsagentur Kleiderprofi	
Bachtar Kleinod oHG	B7.0 G24	Jutta Höbermann	B7.0 C55
Bahl Collection	B7.0 D01	Hats Handelsgesellschaft mbH	B7.0 F62
Manfred Behrens	B7.0 E55	HEIDEKÖNIGIN Textilhandels GmbH	B7.0 B53
Bender-Schmuck Dominik Bender und Hermann Bender GbR		Monika Herré	B7.0 F44
Création Amélie	B7.0 B01	HIGHLIGHT Company Carla Kemper	B7.0 B40
Biba B.V.	B7.0 F01	Himalaya Textilhandels GmbH	B7.0 D62
Bloomers	B7.0 A47	hoffnungsträger Inh. Alexa Lutz	B7.0 C27
Blue Beads Company	B7.0 G07	Sabine Hofius Design GmbH	B7.0 D36
BMS Bernd-Michael Schröder		Hühnerlounge, Inh. Tina Schuster	B7.0 C31
Sailing Wear GmbH	B7.0 C35	Hultquist ApS	B7.0 F15
Bodywings	B7.0 E01	iCrush GmbH	B7.0 E08
BOOM International Trading GmbH	B7.0 C62	ILR Collection	B7.0 G34
Bunte Wolken & CMT		Impala Silberschmuck, Angelika Matuszczak	B7.0 E44
Inh. Yingwen Chen	B7.0 G38	Island Wollparadies	B7.0 G61
buntimo GmbH	B7.0 E49	iXXXi / ELYSEE Uhren GmbH	B7.0 A05
Campur GmbH	B7.0 E07	Jalan-Jalan GmbH	B7.0 A43
CLARO Handels-GmbH	B7.0 E01	Jalfe ApS	B7.0 F53
Cocon Commerz Privatsachen GmbH	B7.0 E46	Jeh Collection BV	B7.0 F41
Colours Cosmetic GmbH	B7.0 B37	J.U.S.T. Trends GmbH	B7.0 E02
The Craftshop DI Dorbath		JustWin Schmuck Design	B7.0 A29
Matthias Stefan	B7.0 F18	KABUKI Country KG	B7.0 C04
Creative Minds Revive B.V.	B7.0 F17	Kashmir Arts	B7.0 A51
Culture Mix B.V.	B7.0 E28	Katahati, Sabine Krummradt	B7.0 F37
DI Perle GmbH	B7.0 F36	KINTAMANI e.K.	
Diggers Garden Warenhandels GmbH	B7.0 C59	Inh. Rainer Schickedanz	B7.0 G56
direkta moden		R. Klee Edelsteinhandlung e. K.	B7.0 A38
Handelsgesellschaft mbH	B7.0 A16	KLP GmbH	B7.0 D29
Antoine Achdjian - Djian Collection	B7.0 C58	Christoph Koch	B7.0 G36
Heidi Dootz Fashion Jewellery	B7.0 F22	Gerdis Koch e.K.	B7.0 B35
Mark Duckworth	B7.0 G60	Kompanie der Weltentaucher	
DUR Schmuck GmbH	B7.0 E03	Inh: Frank Sauer	B7.0 C25
ECHT Schmuck und Design oHG	B7.0 F45	A. Krikor GmbH Mode-Schmuck	B7.0 C02
EfSa-Accessoires Hr. Efresya Yanardag	B7.0 D25	KT-Schmuckdesign GmbH & Co.KG	B7.0 B15
EfSa-Accessoires Hr. Efresya Yanardag	B7.0 D27	Hizkiahu Kupfer	B7.0 C34
Eleganci Taschen, Grande Leder	B7.0 C42	LAURUSCHKUS - the collection, Inhaberin: Valerie Börjes	B7.0 E16
Christian Emig Schmuck & Mineralien	B7.0 D14		

Halle B7 Hall B7

Schmuck & Mode
Jewellery & Fashion



Halle B7 Hall B7

Schmuck & Mode
Jewellery & Fashion



Kashmir Arts	B7.0 A51	Amberworld Bernsteinmanufaktur	B7.0 D15
A. Ahmaddy Tücher und Schals	B7.0 A62	Hamburg Jens von Holt e.K.	B7.0 D24
Bender-Schmuck Dominik Bender und Hermann Bender GbR		Storch-Schmuck	B7.0 D25
Création Amélie	B7.0 B01	EfSa-Accessoires Hr. Efresya Yanardag	B7.0 D27
SILBERPFEIL Lübeck	B7.0 B02	EfSa-Accessoires Hr. Efresya Yanardag	B7.0 D29
GO2 GmbH	B7.0 B10	KLP GmbH	B7.0 D34
KT-Schmuckdesign GmbH & Co.KG	B7.0 B15	zaZa'z	B7.0 D35
mekhada – Irmtraud Schmidt	B7.0 B19	Shaghafi GmbH	B7.0 D36
Spiegelbild Leo Lander	B7.0 B22	Sabine Hofius Design GmbH	B7.0 D37
Sergio Engel Jewellery e.K.	B7.0 B25	Madame Butterfly Modeschmuck Einzel- und Großhandels GmbH	B7.0 D40
Michael Gori - Joid'Art, Barcelona	B7.0 B30	SHOWROOM 019°	B7.0 D41
Aqua dulce v/Janne Lisberg Fisker	B7.0 B34	Australian Fashion House GmbH	B7.0 D42
Gerdis Koch e.K.	B7.0 B35	Pyramide Schmuck-Kreation Elke Singer e.K.	B7.0 D42
Yam Yam Fashion Christian Behr GmbH	B7.0 B36	VE&TO Concept Tomislav Blazevic	B7.0 D42
Colours Cosmetic GmbH	B7.0 B37	AS Bekleidungswerk GmbH	B7.0 D43
Wilkens Handelsvertretung	B7.0 B39	ALKENA GmbH	B7.0 D45
HIGHLIGHT Company Carla Kemper	B7.0 B40	Goldline GmbH	B7.0 D51
MELA	B7.0 B42	Fun of Europe Handels GmbH	B7.0 D54
MN-TRENDS Markus Nitsch	B7.0 B43	Estelle e.K.	B7.0 D55
HEIDEKÖNIGIN Textilhandels GmbH	B7.0 B53	MALIQUE	B7.0 D59
Flomax Naturmode GmbH	B7.0 B56	S. Schweikardt Moden GmbH	B7.0 D60
Praechtig-Berlin Modeagentur Christian Neubauer	B7.0 B57	Himalaya Textilhandels GmbH	B7.0 D62
PEES Accessoires GmbH	B7.0 C01	Bodywings	B7.0 E01
A. Krikor GmbH Mode-Schmuck	B7.0 C02	CLARO Handels-GmbH	B7.0 E01
Goldline GmbH	B7.0 C03	J.U.S.T. Trends GmbH	B7.0 E02
KABUKI Country KG	B7.0 C04	DUR Schmuck GmbH	B7.0 E03
umjubelt by Kokopelli Inh. Kerstin Wein	B7.0 C14	Campur GmbH	B7.0 E07
V.O.F. O.T.R.A COSA	B7.0 C21	iCrush GmbH	B7.0 E08
Kompanie der Weltentaucher Inh: Frank Sauer	B7.0 C25	Possum GmbH	B7.0 E14
hoffnungsträger Inh. Alexa Lutz	B7.0 C27	SENCE Copenhagen Priess Ettema Ning AG	B7.0 E15
Hühnerlounge, Inh. Tina Schuster	B7.0 C31	LAURUSCHKUS - the collection, Inhaberin: Valerie Börjes	B7.0 E16
Nappa Lux Lederwaren GmbH	B7.0 C33	Pilgrim - Vertreten durch Agentur Gitte Cimander	B7.0 E20
Hizkiahu Kupfer	B7.0 C34	OOZOO Timepieces	B7.0 E22
BMS Bernd-Michael Schröder Sailing Wear GmbH	B7.0 C35	Culture Mix B.V.	B7.0 E28
Silk Route V.O.F.	B7.0 C36	Tipico - eigenArt - J. Trenker	B7.0 E32
Eleganci Taschen, Grande Leder	B7.0 C42	Lizas GmbH & Co. KG	B7.0 E35
pos.sei.mo Marianne Birkenfeld	B7.0 C51	LuLu Design, Lu Ji	B7.0 E36
Funny Girl Z. Hill	B7.0 C52	Ariana Lapis e.K.	B7.0 E37
Madness The Nature Textile Company GmbH	B7.0 C53	Umiwi Accessoires	B7.0 E39
SUN Kaschmir-Textilien GmbH	B7.0 C54	Vintageliebe	B7.0 E42
Handelsagentur Kleiderprofi Jutta Höbermann	B7.0 C55	Grethe Winter UG	B7.0 E43
Fortschritt-Berlin e.K.	B7.0 C56	Impala Silberschmuck, Angelika Matuszczak	B7.0 E44
Antoine Achdjian - Djan Collection	B7.0 C58	Cocon Commerz Privatsachen GmbH	B7.0 E46
Diggers Garden Warenhandels GmbH	B7.0 C59	Noble Wilde	B7.0 E47
Neuhaus Lederwaren	B7.0 C60	buntimo GmbH	B7.0 E49
BOOM International Trading GmbH	B7.0 C62	Primetta GmbH & Co. KG	B7.0 E50
Bahl Collection	B7.0 D01	Stulpenkult	B7.0 E52
Stephisimo Stephan Singer e.K.	B7.0 D03	SALTO Mode Inh. Thomas Schubert	B7.0 E53
Trendwerkk GmbH	B7.0 D04	Norwegische LebensArt Modeagentur Else Mortensen GbR	B7.0 E54
PLATA PA'TI Jörg Wilitzki	B7.0 D07	Manfred Behrens	B7.0 E55
Christian Emig Schmuck & Mineralien	B7.0 D14	Senatex GmbH	B7.0 E56
		SeaBright GmbH	B7.0 E57

Halle B7 Hall B7

Schmuck & Mode
Jewellery & Fashion



McRon Fashion GmbH & Co. KG	B7.0 E62	Magic Pearl Aruba	B7.0 G40
Biba B.V.	B7.0 F01	Siegfried Giede GmbH	B7.0 G41
Gubo Schmuck Inh. Thomas Gubo	B7.0 F03	Aluna - Schmuckdesign	
Pink City e.K.	B7.0 F05	Einzelunternehmen Regina Rösler	B7.0 G44
Hultquist ApS	B7.0 F15	Skyrace e.K.	B7.0 G44
Unik Collection Gunda Bieber	B7.0 F16	Estelle Silver - Tanja Baur	B7.0 G46
Creative Minds Revive B.V.	B7.0 F17	Me Lady B.V.	B7.0 G51
The Craftshop DI Dorbath		KINTAMANI e.K.	
Matthias Stefan	B7.0 F18	Inh. Rainer Schickedanz	B7.0 G56
B-Latitude Inh.: Françoise Saegebrecht	B7.0 F20	Mark Duckworth	B7.0 G60
Alexandra Staffel-de Jong	B7.0 F21	Island Wollparadies	B7.0 G61
Heidi Dootz Fashion Jewellery	B7.0 F22		
LeJu Ltd	B7.0 F25		
tendance-Silberschmuck			
Angela Grannemann	B7.0 F28		
Lorena, RB-Schmuckproduktions GmbH	B7.0 F29		
Atlantis Accessories GmbH	B7.0 F30		
MareSchmuck OHG	B7.0 F33		
AJOLA® GbR	B7.0 F34		
Mystic Maya Verónica Lara Castillo	B7.0 F35		
DI Perle GmbH	B7.0 F36		
Katahati, Sabine Krummradt	B7.0 F37		
GEORG Jerzy Lesniak	B7.0 F38		
ADI-Modeschmuck			
Inh. Sabine Schifferer	B7.0 F39		
Detlef Menard P&A	B7.0 F40		
Jeh Collection BV	B7.0 F41		
Namaste Anke Dessauer	B7.0 F42		
PM next GmbH	B7.0 F43		
Monika Herré	B7.0 F44		
ECHT Schmuck und Design oHG	B7.0 F45		
pakilia GbR	B7.0 F46		
Aslan Bijuteri			
Taki San. ve Dis Tic. Ltd. Sti	B7.0 F49		
Nepalaya fair fashion & filz accessoires	B7.0 F50		
Jalfe ApS	B7.0 F53		
Green Factory Colombia GmbH	B7.0 F54		
Hats Handelsgesellschaft mbH	B7.0 F62		
Silber für Schmuck - Gudrun Haug	B7.0 G04		
Siddhartha	B7.0 G05		
Willi Weber & Sohn GmbH	B7.0 G06		
Blue Beads Company	B7.0 G07		
Mertens Import-Export GmbH & Co. KG	B7.0 G08		
Michael Utzerath GmbH	B7.0 G15		
Steindesign GmbH	B7.0 G16		
Mineralien- u. Schmuckhandlung			
Frank Steinbach & Co. OHG	B7.0 G20		
Geo-Expert Michael Vogt	B7.0 G21		
Bachtar Kleinod oHG	B7.0 G24		
Terré Spirit of Stones			
Inh. Susanne Kern	B7.0 G28		
Fashion Company Aps	B7.0 G31		
Eva Stone & Glitter			
Kazimierz Szyszko, Ewa Szyszko	B7.0 G33		
ILR Collection	B7.0 G34		
Christoph Koch	B7.0 G36		
Lillis Steine	B7.0 G37		
Bunte Wolken & CMT			
Inh. Yingwen Chen	B7.0 G38		